

RADIO'S LIVEST MAGAZINE

SPECIAL  
BROADCAST  
NUMBER

OVER 175 ILLUSTRATIONS

# Radio-Craft

★

HUGO GERNSEBACK Editor

February

25¢

In United States  
and Canada

60 TONS  
OF ANTENNA!

See Page 462

How to Stage a Home Broadcast — Making a Simple 4-Tube Radio Receiver  
One Antenna for Simultaneous 2-Way Radio — More About Volume Expansion

OVER 50,000 RADIO MEN READ RADIO-CRAFT MONTHLY



**Once in a Lifetime**  
**WE CELEBRATE**  
**RADIO'S GOLDEN JUBILEE**

**50 Years of Radio Progress**

JUBILEE SOUVENIR NUMBER

MARCH

50 Cents

# Radio-Craft

HUGO GERNSBACK, Editor

**50 Years of Radio**



Reminiscences of Old-Timers — Progress of Radio Sets — Radio in the Future  
 Most Famous Circuits in Radio History — A Chronological History of Radio

*Will Be Depicted in*  
**MARCH '38 RADIO-CRAFT—**

**JUBILEE  
 SOUVENIR  
 NUMBER**

**Here are the highlights:**

- Story of Amateur Radio • Progress of Radio Receivers • Grand Old Men of Radio • Radio Parts of Yesteryear • Early Forecasts and Their Fulfillment • Car-Radio Sets—From 1901! • Chronological History of Radio • Reminiscences of Old-Timers • From Fleming Valve and Up • Good Old Set-Building Days • Famous Stations in Radio History • Famous Radio Stations • Special Old Timers' Page • Feature Radio Articles • and many more sensational articles to bring fond memories—

**And here are more features:**

- MORE THAN DOUBLE THE USUAL NUMBER OF PAGES
- COVER ATTRACTIVELY PRINTED IN FOUR COLORS AND GOLD
- SPECIAL, NEW COVER AND BODY PAPER
- HUNDREDS OF OLD TIME DIAGRAM, CIRCUITS, PHOTOS — EQUIPMENT YOU'VE NEVER SEEN BEFORE
- EVERY NEW ADVERTISEMENT WILL BE ACCOMPANIED BY THE REPRODUCTION OF AN OLD ONE — GREATEST THING YOU EVER SAW!
- DIFFERENT FROM ANYTHING EVER PUBLISHED IN A RADIO MAGAZINE
- NEWSSTAND PRICE — 50¢ A COPY

*No Additional Cost to Regular Mail Subscribers*

• MORE THAN DOUBLE THE USUAL NUMBER OF PAGES •

Look for the **GOLD COVER** on the  
**JUBILEE SOUVENIR NUMBER**

**MARCH, 1938 RADIO-CRAFT - - ON NEWSSTANDS FEBRUARY 5TH**





*I jumped from \$18 a week to \$50*  
*-- a Free Book started me toward this*  
**GOOD PAY IN RADIO**

**HERE'S**  
*How it*  
*Happened*  
 by **S. J. E.**  
 (NAME AND ADDRESS  
 SENT UPON REQUEST)



"I had an \$18 a week job in a shoe factory. I'd probably be at it today if I hadn't read about the opportunities in Radio and started training at home for them."



"The training National Radio Institute gave me was so practical I was soon ready to make \$5, \$10, \$15 a week in spare time servicing Radio sets."



"When I finished training I accepted a job as serviceman with a Radio store. In three weeks I was made service manager at more than twice what I earned in the shoe factory."

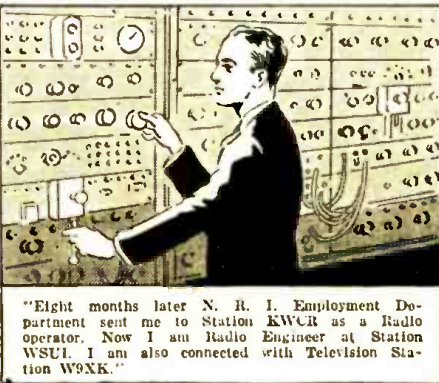

"Eight months later N. R. I. Employment Department sent me to Station KWCR as a Radio operator. Now I am Radio Engineer at Station WSUI. I am also connected with Television Station W9XK."

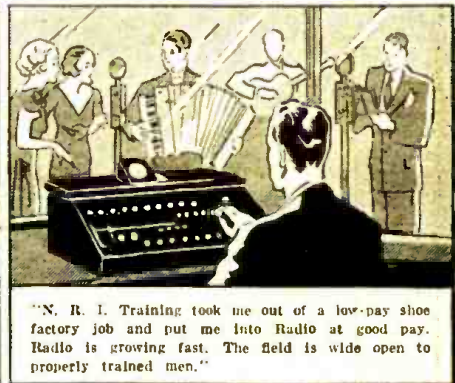

"N. R. I. Training took me out of a low-pay shoe factory job and put me into Radio at good pay. Radio is growing fast. The field is wide open to properly trained men."



*Find out today* how I Train You at Home  
**to BE A RADIO EXPERT**

**Many Make \$30, \$50, \$75 a Week**

Do you too want a better job? Do you too want to make more money? Radio offers many spare time and full time opportunities for good pay.

**Get Ready Now For Jobs Like These**

Broadcasting stations employ engineers, operators, station managers and pay up to \$5,000 a year. Spare time Radio set servicing pays many \$200 to \$500 a year—full time servicing jobs pay many \$30, \$50, \$75 a week. Many Radio Experts are operating full or part time Radio businesses. Radio manufacturers and jobbers employ testers, inspectors, foremen, engineers, servicemen, paying up to \$6,000 a year. Radio operators on ships get good pay. see the world. Automobile, police, aviation, commercial Radio, loud speaker systems, offer good opportunities now and for the future. Television promises good jobs soon. Men I trained have good jobs in these branches of Radio.

**Many Make \$5, \$10, \$15 a Week Extra in Spare Time While Learning**

The day you enroll I start sending you Extra Money Job Sheets. They show you how to do Radio repair jobs; how to cash in quickly. Throughout your training I send plans and ideas that make good spare time money—from \$200 to \$500 a year—for hundreds of fellows. I send special Radio equipment, give you practical Radio experience—show how to conduct experiments, build circuits illustrating important Radio principles.

**I Give You a Professional Servicing Instrument**



Here is the instrument every Radio expert needs and wants—an All-Wave, All-Purpose, Set Servicing Instrument. It contains everything necessary to measure A.C. and D.C. voltages and current; test tubes, resistance; adjust and align any set, old or new. It satisfies your needs for professional servicing after you graduate—can help you make extra money servicing sets while training.

**Find Out What Radio Offers You**

Mail the coupon now for my Book, "Rich Rewards in Radio" and a sample lesson. They're free to any fellow over 16 years old. My book points out Radio's spare time and full time opportunities, also those coming in Television; tells about my Training in Radio and Television; shows you 131 letters from men I trained, shows what they are doing, earning; shows my Money Back Agreement. MAIL COUPON in an envelope, or paste on penny post card—NOW!

**J. E. SMITH,**  
 President, Dept. 88X  
 National Radio Institute,  
 Washington, D. C.

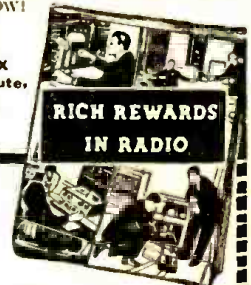

**J. E. SMITH, President, Dept. 88X,  
 National Radio Institute, Washington, D. C.**

Dear Mr. Smith: Without obligation, send me free a Sample Lesson and your 64-page Book, "Rich Rewards in Radio," telling about spare time and full time Radio opportunities, and how I can train for them at home in spare time. (Please write plainly.)

Name ..... Age .....

Address .....

City ..... State ..... 14x1

Please Say That You Saw It in RADIO-CRAFT





HUGO GERNSBACK, Editor-in-Chief  
 N. H. LESSEM Associate Editor  
 C. P. MASON Associate Editor  
 R. D. WASHBURNE, Managing Editor

**CONTENTS — FEB. 1938, ISSUE**

Volume IX Number 8

Editorial: Visual Broadcasting.....Hugo Gernsback 453  
 The Radio Month in Review..... 454  
 Preview of 1938 Fashions—Successfully Televised!.... 456  
 Let's Peek in at Television with Two of Its Leaders  
 .....David Sarnoff and Dr. A. N. Goldsmith 457  
 Pushbutton Tuning—Replaces Dial Twisting  
 .....N. H. Lessem 458  
 The Radio Club Chair!..... 460  
 New Condenserless Tuning System Demonstrated!  
 .....W. E. Shrage 461  
 60 Tons of Antenna!..... 462  
 Television Students Learn by Making Cathode-Ray  
 Tubes—Part IV.....U. A. Sanabria 462  
 Television "Piped" 100 Miles.....Frank B. Jewett 463  
 Volume Expansion—Modernized....Clifford E. Denton 464  
 How to Stage a Home Broadcast.....Robert Eichberg 466  
 Sound Effects—The British Way..... 467  
 How to Make the *Radio-Craft* Super-Deluxe 30-Tube  
 Set—Part V ..... 468  
 "Bimetallic Condenser" Aids Tuning!..... 470  
 New Equipment for All-Wave Radio..... 471  
 How to Make a Simple 4-Tube Regenerative A.C.-  
 D.C. Superhet.....M. N. Beitman 472  
 2-Way Police Radio Over 1 Antenna!  
 .....C. W. Palmer 473  
 International Radio Review..... 474  
 How Radio Handled the Elections!..... 475  
 Servicing Instruments for 1938..... 476

New Circuits in Modern Radio Receivers—No. 5  
 .....F. L. Sprayberry 477  
 The Latest Radio Equipment..... 478  
 "Learn-by-Experimenting" Beginners' Practical Radio  
 Course—Experiment No. 5A.....Sol D. Prenskey 480  
 Servicing Questions & Answers..... 481  
 Operating Notes ..... 481  
 New Radio Items for Car Owners....R. D. Washburne 482  
 2,000 Parts Make 1 Modern Radio Set!  
 .....Paul P. Smith 483  
 A New V.-T. Voltmeter.....Mack Stier 483  
 RADIO SERVICE DATA SHEETS:  
 No. 221—Philco Model 38-116; Code 125..... 484  
 No. 222—Ditto (continuation) ..... 485  
 Is Radio Servicing Merely a Stepping-Stone to High-  
 er Positions in the Industry?..... 486  
 "Noise Eliminator" for Wind-Charger Generators  
 .....M. M. Lasensky 511  
 Book Review ..... 512

**IMPORTANT!! MARCH RADIO-CRAFT  
 JUBILEE SOUVENIR NUMBER**

The forthcoming March issue of *Radio-Craft* will absolutely be the most outstanding since the inception of this publication. It will contain more than *double the usual number of pages*. "50 Years of Radio" will be covered by this special edition and such subjects as "Famous Old Radio Circuits," "Reminiscences of Old-Timers," "A Chronological History of Radio," "Old Radio Receivers" and "Radio Parts," as well as the regular material dealing with the latest in Servicing, Public Address, etc.

We know that all old-timers, as well as the comparatively new men in radio, will be greatly interested in this special edition. Its contents will always bring forth fond memories, and will be cherished through the years to come.

Published by Radcraft Publications, Inc. Publication office: 29 Worthington Street, Springfield, Mass. Editorial and Advertising Offices: 99 Hudson Street, New York City. Chicago Advertising Office: RADIO-CRAFT, 520 North Michigan Avenue, Chicago, Ill.

Foreign Agents:

London—Gorrings American News Agency, 9A Green St., Leicester Square, W. C. 2, England.  
 Paris—Messageries Dawson, 4 Rue Faubourg, Poissonniere, France.  
 Melbourne—McGill's Agency, 179 Elizabeth St., Australia.  
 Dunedin—James Johnston, Ltd., New Zealand.

RADIO-CRAFT is published monthly, on the first of the month preceding that of date; subscription price is \$2.50 per year in U. S. and Canada. (In foreign countries, \$3.00 a year to cover additional postage.) Entered at the post office at Springfield as second-class matter under the act of March 3, 1879.

Text and illustrations of this magazine are copyright and must not be reproduced without permission of the copyright owners.

Copyright 1938 Radcraft Publications, Inc.



# TRAIN FOR RADIO IN 12 WEEKS

## BY MY QUICK, EASY "LEARN BY DOING" METHOD



Prepare today to enter a real money-making field by my quick, easy way to learn Radio. Here in my school you are trained in 12 weeks for your start for a better job and a real future. You do actual work on a great outlay of Radio equipment. The remarkable "Learn-By-Doing" methods used in the great Coyne Shops train you in **Radio, Television** and sound equipment servicing. Not by books . . . Not by Correspondence . . . But all under the individual guidance of skilled instructors, and only on similar kind of work you will meet out on a real job. My methods make it **easy to learn**—First you are told how to do a thing—then you are shown how to do it—then you do the work yourself. WHERE ELSE CAN YOU FIND SO QUICK AND EASY A WAY TO GET PRACTICAL TRAINING IN THIS GIANT INDUSTRY?

# I'LL FINANCE YOUR TRAINING

**DON'T LET LACK OF MONEY** keep you from sending in the Coupon TODAY. Learn how you can get training first and take more than a year to pay for it after graduation. Make your first payment 60 days after your regular 12 weeks' training period ends. Then take over a year to pay the balance of your tuition in easy monthly payments. Hundreds of ambitious fellows have used this method to get Coyne Training. **FILL IN THE COUPON AND MAIL IT TODAY.** It will bring you the details of this amazingly quick and easy way to get your start towards a good pay job.

### Radio—Television—Sound Equipment

Your training at Coyne is in wonderful, modern daylight shops on the finest kind of RADIO, TELEVISION and SOUND EQUIPMENT. Television is sure to come as a commercial industry, whether this year or next. Talking Picture and Public Address Systems offer opportunities for the trained man. Everything possible has been done to make your stay at Coyne happy and healthful as well as profitable.

### Electric Refrigeration Training Included at No Extra Cost

This combination Training (Radio and Refrigeration) can be of great value to you. Whether you go into business for yourself or get a job working for a Radio Sales and Service organization, the fact that you are trained in servicing Electric Refrigerators should be profitable to you. Many Radio Manufacturers also make Electric Refrigerators and men with this combination training are much more valuable to these employers. You can NOW get this training without extra cost.

### No Advanced Education or Previous Experience Needed

If you can read and write simple English and are ambitious you can be trained the Coyne way—by actual experience on a wide variety of up-to-date Superheterodyne sets, oscillators, analyzers, and test instruments. You learn how to operate television receiving and transmitting equipment and how to install, test and service public address systems and sound picture equipment. Coyne training also helps prepare you to qualify for a government license examination as Amateur Broadcast or Telegraph Radio Operator and to know Code and Department of Commerce rules. Send coupon for all details.



*H. C. Lewis*

### Part Time Work While Learning Employment Service after Graduation

If you need part time work to help pay living expenses while training, my Employment Department will help you get it. They will also give you Lifetime Employment Service after you graduate.

### Mail Coupon Today I'll Send You All the Facts

Get the new "Coyne Opportunity Catalog," giving all facts about Coyne Training. Photographs of Shops showing students at work on modern radio equipment under the personal supervision of Coyne Expert Instructors. Also details of my Part Time Employment Offer. Pay After Graduation Plan and Graduate Employment Service. Yours without cost. Simply Mail the Coupon.



H. C. LEWIS, President,  
Radio Division, Coyne Electrical School,  
500 S. Paulina St., Dept. 28-8H, Chicago, Ill.

Send me your big FREE Book about Coyne Training and give me all details regarding your "Part Time Employment Offer" and "Pay After Graduation Plan" of easy, monthly payments.

NAME.....AGE.....  
ADDRESS.....  
CITY.....STATE.....

**H. C. LEWIS, President RADIO DIVISION Founded 1899**  
**COYNE ELECTRICAL SCHOOL**  
**500 S. Paulina St., Dept. 28-8H, Chicago, Ill.**

Please Say That You Saw It in RADIO-CRAFT



# Here is a **NEW FREE BOOK** Which Every Radio Man Can Use to Advantage!

**An Extended Opportunity to Get This Book!**  
**Final Offer Expires January 31, 1938.**

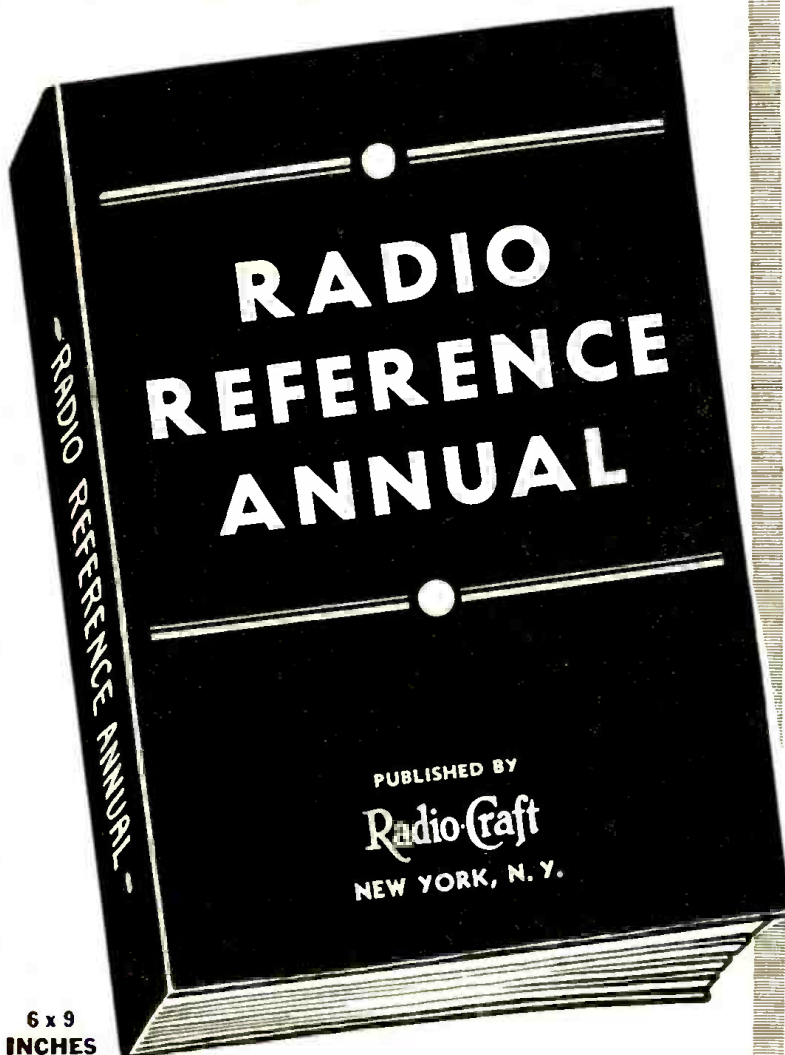

6 x 9  
INCHES

**OVER 125 ILLUSTRATIONS**

THE Editors of RADIO-CRAFT have prepared a special book for you. This book—the RADIO REFERENCE ANNUAL—is not for sale, but available only to subscribers, both new and old, with a *Seven Months' Subscription* to RADIO-CRAFT. If your subscription expires shortly, you have the privilege of extending your subscription for seven months, and still receive the FREE premium. The price of this Special Offer is only One Dollar (\$1.00)—and as an additional saving, the book is mailed to you *post-paid*, just as the magazine is each month. Carefully outlined at the top right column is the contents of this book; it contains information which every radio man needs. The book contains 64 pages, size 6 x 9, and is replete with illustrations.

**RADIO-CRAFT**  
99 Hudson Street, New York, N. Y.

## Read These Interesting Chapter Headings of the RADIO REFERENCE ANNUAL

### Receiver Construction

Building a 12-tube All-wave DX receiver—How to make a modern 6-tube Car Radio set—building up a 2-tube Beginner's Set, with several different power supplies for various uses—Constructing a 2-tube midget set for portable use—How to build a "talking" briefcase—no aerial or ground needed.

### Audio and P. A. Equipment

Making an Audio Bass Booster, using direct coupling—How to build and add a Dual-Channel Amplifier to your receiver—Constructing a High-Fidelity Amplifier—Construction of a 3-tube A.C.-operated Preamplifier—Fundamentals of "Decibel Level" and "Decibel Gain".

### Test Equipment—Construction

How to make an "Electronic Eye" output meter—How to construct an ultra-compact Universal Volt-Ohm-Milliammeter—How to make a Resistance-Capacity tester—How to Build a Pocket Adapter for set testing—Building a Portable Capacity bridge—Construction of a V.T. Voltmeter in compact form—How to Make a Modern Set Analyzer.

### Articles for the Service Man

Servicing with the Oscilloscope—Servicing with a Single Meter—"What's Wrong With Your Radio" chart—Tapers of Volume Controls, and use of various types—Ideas for the Service Shop—Aligning All-Wave receivers.

### Time and Money-Saving Kinks

In this section you profit by the experience of other radio men. These kinks are really valuable "short-cuts" which save much time and, very often, money. They are "pet" ideas put into practice.

### Important Articles Which Have Appeared in RADIO-CRAFT

#### General Interest Articles

Design of Transformers for Class "AB" and "B" operation—A table of Inter-Electrode Capacities for 30 different tube types—How to make a Floating-Grid Relay—Construction of a modern Treasure Locator—How to get DX on your All-Wave Radio—Making a 5-meter Transceiver for use in car or boat.

#### New Tubes

Characteristics of the Newest Receiving Tubes of all manufacturers, giving uses, characteristics, present equivalents (if any) and all pertinent data.

## MAIL COUPON TODAY!

**RADIO-CRAFT, 99 Hudson St., New York, N. Y.**

Gentlemen: Enclosed you will find my remittance of One Dollar (\$1.00) for which enter my subscription to RADIO-CRAFT Magazine for Seven Months. Send me **ABSOLUTELY FREE**, and **POSTPAID**, my copy of the **RADIO REFERENCE ANNUAL**. (This Offer Is Good Only in U.S.A. and Canada—Foreign \$1.50.)

Name ..... Address .....

City ..... State .....

(Send remittance by check or money order. Register your letter if you send cash or unused U. S. Postage Stamps.) RC-2-38

Please Say That You Saw It in RADIO-CRAFT





"Takes the Resistance out of Radio"

Editorial Offices: 99 Hudson St., New York, N. Y.

HUGO GERNSBACK, Editor

Vol. IX, No. 8, February, 1938

## VISUAL BROADCASTING

An Editorial by HUGO GERNSBACK

**W**HILE *visual broadcasting*—television—has not as yet "arrived" for the general public, the time is constantly drawing nearer when this promise will be fulfilled. As is well known, formidable difficulties are still to be overcome before visual broadcasting becomes a reality. The chief obstacles, at the present time, may be summed as follows:

(1) Present television receivers, so far as cost is concerned, are out of reach of the public. There are almost 30,000,000 radio receivers in use in the United States at the present time, the average cost of each to the public being less than \$40. The present cost of a television receiver—\$400, or more—is an impossible economic obstacle in the path of visual broadcasting.

(2) Technical deficiencies of present television receivers, such as low luminous intensity (reception must be in semi-darkness), image view from only one point, instead of from every direction in the room, are also important factors in the progress of television. Further, present-day television receivers are not well enough perfected so that a non-technical individual can operate one *at all times*. Finally, a good television-image or video receiver must have 10 times the fidelity of a modern "hi-fi" radio receiver.

(3) The present high cost of visual broadcasting presentations in television studios.

(4) The staggering cost of linking broadcasting stations by coaxial cables into a national network.

There are other difficulties yet to be overcome, but those cited are the chief barriers which are holding back television or visual broadcasting. And let no one run away with the often-voiced chestnut, current in lay circles, that "the 'Radio Trust' is purposely holding television back." Nothing could be further from the truth; and such a contention, in view of the above-mentioned difficulties, becomes more or less ridiculous.

But let us suppose that all of these obstacles have been overcome, at some time in the future. Let us now look into the television studio of a big visual broadcasting key station, and let us see wherein visual broadcasting in the future differs from present-day broadcasting.

At the present time, when a sponsor broadcasts, let us say, a condensed version of Grand Opera it is, of course, not necessary to construct a stage with all the paraphernalia which accompany it, as on the Metropolitan Opera House stage. As a rule, a few singers group themselves around a microphone, and sing against a musical background. With visual broadcasting, this obviously can no longer be done. In other words, when radio adds sight to present sound, it will become necessary to go the limit for presentation purposes; and that means future visual broadcasting stations must indeed become not merely theatres, Grand Opera houses, or motion picture studios, *but all three combined*.

The technical resources, required to put on a visual show, are so complex and so tremendous that, up to now, it has usually frightened broadcast interests; because they could not see how any sponsor can possibly foot the huge costs which a big broadcast would entail.

Fortunately, it may not be as formidable as all this when visual broadcasting finally arrives. There are all sorts of tricks in every trade and, just as the technicians in present broadcasting studios deceive the ear by synthetically creating noises, ranging from a roaring throng of 5,000 baseball fans, to the roar of wild animals (and usually produced from phonograph records), so in the future your eyes will be deceived by the most marvelous scenery which will be devised especially for the visual broadcasting studios.

This trick of creating scenic backgrounds of the most impressive types, is already well advanced in the motion picture field, where unheard-of effects are produced so cheaply that no one would have thought them possible, a few years back.

Nowadays, when, let us say, a moving background of New York skyscrapers is needed, the moving picture company does not have to travel to New York with its equipment. Instead, a studio camera man goes *alone* to New York and takes whatever motion pictures are required of the New York skyscrapers, with the river, and the steamships or ferryboats plying about Manhattan Island. The film is then developed in Hollywood, and projected against the *back* of a translucent screen. The actors now stand in front of this screen, and are photographed by another cameraman. The resulting picture shows the actors disporting themselves against a moving background of New York City skyscrapers! That this, and similar technique, will be used in visual broadcasting is certain. The cost of production will be cut down enormously as the art progresses, yet will give to the public most enjoyable presentations.

As time goes on, other similar new inventions will be added to television broadcasting technique and, indeed, the cost of visual broadcasting, except under unusual circumstances, will then not be larger than presentations of our present-day audible broadcasts. After all, the human element will still be the important factor; and when it comes to outdoor "spot" (outside pick-up) visual broadcasting—such as the transmission of a baseball game, a fire, or an inauguration of the President—the actual cost to video broadcast interests will compare favorably with presentation costs of audio broadcasts today. Another advantage is that, although sound effects often must be faked in regular broadcasts in order to create an illusion of reality, in putting on a television spot broadcast a wider sound range is available which makes it possible to utilize many natural sound effects.



# THE RADIO MONTH



Cynophilist Dr. George Cohen and his bulldog Duke, whom he equipped with an acoustic to restore hearing. Now the old dog can be taught new tricks.

## ON SHORTWAVES AND LONGER ONES

**10** to 25 miles is the commonly estimated range of television and hi-fi systems on ultra-shortwaves with which experimental work is increasingly carried on. Still, W2XOY, the G.E. 7.3-meter station on the N. Y. state office building, Albany, intended for local work, received its first reception letter last month from Phoenix, Ariz., 2,000 miles away!

Code ringing, by remote control, is part of the design of the 10-meter radio-telephone system between California Tech. and the Mount Palomar Observatory, Austin Bailey reported last month in the *Bell Laboratories Record*. The 90 miles was spanned, with an 18-db. loss due to a mountain range between, with 5-watt transmitters; but to overcome ignition interference, 40 watts was added to the power. In the system, a metal water tower serves as a reflector to strengthen a directional beam.

Incidents in peaceful China compelled U. S. action last month when the F.C.C. authorized changeover of communication licenses because of the destruction of the Chenju receiving station. And the Manchuria T. & T. Co. announced in Japan that it will put up broadcast stations in North China next year.

For police and municipal use, 29 frequencies above 30,000 kc. were made available last month by the F.C.C., with rules to be formulated later.

Anti-police transmitters are a problem of European authorities, according to a report from Paris in *Reynolds News* (London) last month. Crooks, it is asserted, carry pocket receivers to get code messages, on frequently changed wavelengths.

With official acknowledgement that

American radio must keep up with the march of foreign propaganda, the F.C.C. last month took under advisement distribution of channels for Latin-American broadcasts. General Electric announced a series of strictly U. S. news broadcasts from W2XAD and W2XAF. Westinghouse announced new "rhombic" directional antennas for W8XK to step up beam signals from 25 to 50 times, gain being greatest at high frequencies.

Recognizing the right of every nation to use every broadcast channel, as a matter of sovereignty, the Inter-American radio conference at Havana last month called for agreements between neighboring countries to prevent interference. Encouragement of aviation radio, and of radio exchange of weather reports was urged.

## TELEVISION LIGHTS AND SHADOWS

**A**S King George VI stood at attention before the Cenotaph at the Armistice observance last month, a demented person broke into the assembly; and the incident was unexpectedly televised, as well as broadcast, to all England's lookers-in—perhaps 3,000! On the same day, the first broadcast of a complete, full-length play ("Journey's End") by sight and sound was carried out, from B.B.C. studios at Alexandra Palace. It took 80 minutes.

"Television is here," President H. H. Beverage told the I.R.E. last month; "the 'catch' is cost alone, and that is why every radio-minded citizen fails to have a television receiver in his home." In England, reports come, owners of radio sets are asking why their license money (every set must pay \$2.50 a year) should go into television experiments, which they cannot receive, rather than programs which they can?



TANK SERVES AS REFLECTOR

(Bell Telephone Laboratories)

The circle (arrow) shows where an observatory dome will stand on Mt. Palomar, crowned with the 200 in. telescope. Beyond, ultra-shortwave telephone station link to C.I.T. at Pasadena, 90 miles away.

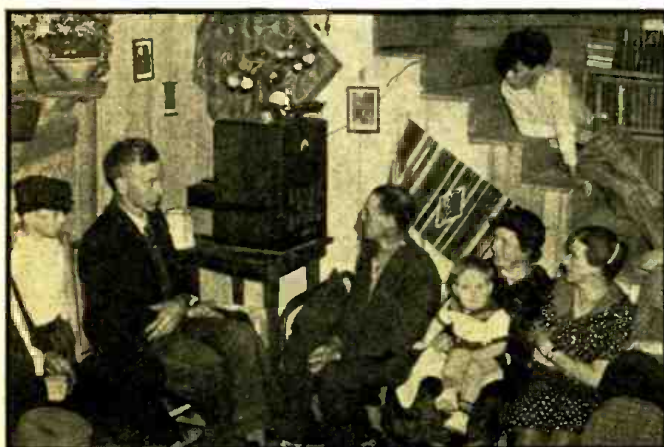

(Photo, Joseph Melvin McElliot)

The University of Kentucky has established radio Listening Centers where, with modern sets provided by donors, rural people are encouraged to gather and listen to educational programs. Here are an interested group in a mountain home.



This broadcast over WOR last month was a bonafide amateur hour; the mike caught taps as unhatched chickens cracked their shells. (Too bad Mr. Rooster and Mrs. Hen did not have the phones on—as a matter of fact, the parents had never met—for these are up-to-date, "test-tube" chicks!)



# IN REVIEW

Radio is now such a vast and diversified art it becomes necessary to make a general survey of important monthly developments. RADIO-CRAFT analyzes these developments and presents a review of those items which interest all.

News reports announced "first reception of television at sea" aboard the liner *Britannic* in the English Channel last month. News reports 10 years ago announced first reception of Baird's early television transmissions at sea; but requirements were much less exacting then. In those days, a 30-line image was remarkable.

## RADIOCURRENCES OF LATE DATE

**S**INKING of the Greek ship *Tzeny Chandris* off stormy Cape Hatteras last month adds one more to the list of radio operators lost at their posts, and brings up again responsibility of captains who delay SOS with loss of life to crew and, perhaps, passengers, in gambling to save ships without salvage liability. News story, that an officer with drawn weapon compelled operator to send call without waiting captain's orders, was later denied.

First broadcast from submerged sub, without cable connection was announced last month. Sounds of torpedoes being fired from U.S.S. *R-14* were heard from New London harbor over NBC, as well as voices of officers and crew. A short antenna attached to the periscope is said to have made it possible.

Danger of having power apparatus too close to water system was again proved last month when Edward G. Gillig, Jr., of Buffalo, N. Y., stepped from a shower beside his basement short-wave outfit and accidentally touched a high-tension electrode, with fatal results.

Public-address amplifier found new use last month when Mrs. Leo J. Heer of Jamestown, N. Y., toured the countryside in a police car, calling her 3 year-old son Timothy, who had disappeared from home. Unfortunately, the

youngster was evidently beyond the range of apparatus.

Conflict between law and medicine was renewed in Los Altos, Calif., last month when police detected that interference on their radio wavelength was due to electric apparatus operated by the health department for germ culture. The "bugs" were removed from the radio, but not from the incubator.

In Uganda, Africa, stated correspondence of *Pearson's Weekly* (London) last month, the price of a wife has gone up to the level of a radio set; for a first-class maiden, a phono-radio may be required, instead of the herd of oxen which was once standard. And good, up-to-date sets are still scarce in that region, to the dismay of impecunious bachelors.

Dedicating new home of N. Y. City-owned WNYC last month, militant Mayor-re-elect La Guardia denounced restrictions on S.-W. relays, by which he hopes to form a chain with other public-owned transmitters. He declared that, if the F.C.C. does not yield on the point, he will seek action from Congress. The new transmitter location (shown by map further on) is central as regards the Greater City, and gives excellent coverage with its 1,000 watts. The 304-foot,  $\frac{1}{4}$ -wave towers are space-phased  $\frac{1}{8}$ -wavelength, and time-phased  $\frac{1}{8}$ -period apart; power is fed to them

(Continued on page 503)



(Photo, BCA-Victor)  
Better go over Niagara Falls in a radio cabinet than in a barrel: at least, in this test of a new "tropic-proof" console, it came through practically undamaged, and the barrel didn't!



(Photo, Indian Trailer Corp.—Supreme Instruments Corp.)  
Meet the Trailing Service Shop, also the home of the Flying Service Man and Mrs. S. M. The Supreme-ly equipped shop, built into the 19-foot trailer as pictured, has its own power system and is prepared to tackle any radio problem. Several of these installations will be on the roads this year.

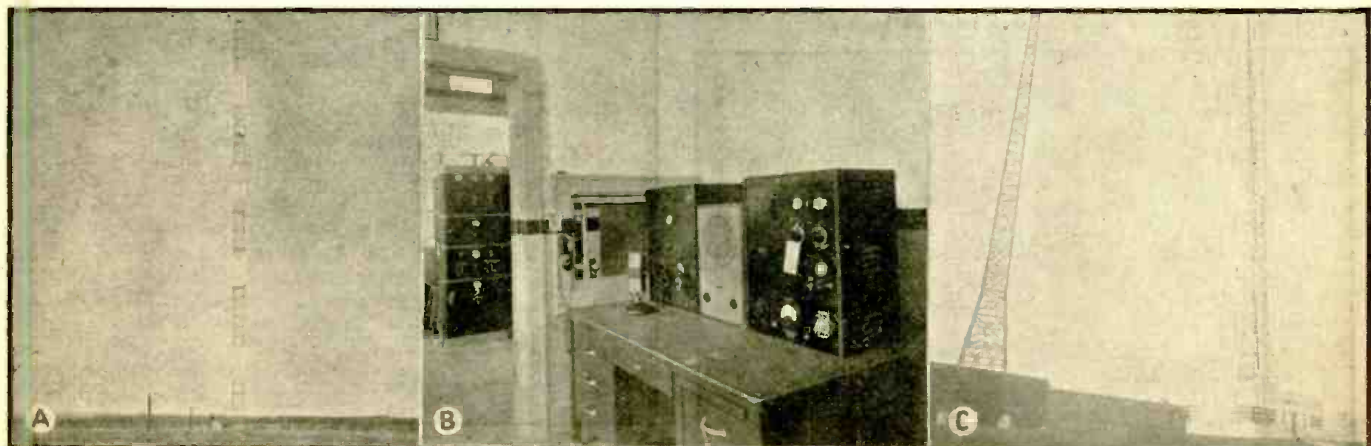
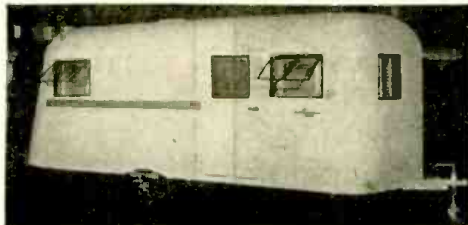

Left, 303-foot tower of one of North Carolina's new highway patrol radio transmitters, which will also serve the state's conservation department to control forest fires; the antenna is designed to "compress" the field into a 75-mile radius. Center, one of the 1,000-watt installations working on 4,706-kc. police channel.

Jowers and transmitter of New York City-owned WNYC. The building, opposite downtown Manhattan, mounts on 99 piles.



# PREVIEW OF 1938 FASHIONS —

When the fashions of 1938 went on parade, last month, improvements in high-definition television technique had at last made it possible to reproduce colors in almost their natural tones of light and dark; and without recourse to the exaggerated coloring so necessary in the earlier days of television. Images were viewed on 7½" x 10" screens.



Fashions debut via television!



Iconoscope "cameras" in action.



Floodlighting the fashions.



Close-up of a fashion-show television model.



Checking illumination with a lightmeter.

## TELEVISION HISTORY —

*Saks Fifth Avenue*



FIRST ALL-FASHION DEMONSTRATION OF TELEVISION . . . FEATURES CLOTHES FROM SAKS FIFTH AVENUE . . . Spotlights, floodlights, iconoscopic cameras, microphones in midair, actors in heavy makeup—a history-making performance, registered on airwaves, transmitted again on top of the television antenna, look again to the RCA building! . . . At four o'clock on November 13, sixty-two stores up in the RCA building, three hundred persons sat before experimental television sets and saw moving images of real people flash before their excited eyes. The first television show on the Continent to concern itself solely and seriously with fashion. Naturally, Saks Fifth Avenue—forward-looking, modern—step ahead, played the major part in this thrilling glimpse into the future with its fashions.

A well-known New York department store, by means of a ¾-page ad. (reproduced above) in the *New York Times*, helped publicize an epochal event in television. The *Times'* daily circulation is about 600,000 copies.



# SUCCESSFULLY TELEVISED!

On November 18th, 1937, about 300 persons — stylists, fashion writers, designers, executives—witnessed the first all-fashion television show on this continent.

Images were sent over coaxial cable from the RCA building to the Empire State building; and received at the RCA building on 20 ultra-shortwave television receivers.

**T**HE FASHION SHOW of the future was heralded by an NBC television demonstration staged this winter. In it, radiant models, arrayed in attractive gowns, paraded with stately steps before the cold, grim eye of the iconoscope—and the more appreciative eyes of the engineering staff. At some 20 receivers (on the 62nd floor of the RCA building), observers watched—and saw even such fine details as the grain of the leather in luggage accessories.

## THE GAMUT OF THE SHOW

The new high-definition pick-ups and reproducers (441-line cathode-ray scanning) were able to show details hitherto considered too fine for the medium. In the tests, broad stripes, large patterns and other showy details were omitted. The models wore practical travel, sports, evening and negligee costumes. A hairdresser demonstrated a new "stardust" evening coiffure in the process of creation, and then rearranged it for daytime wear. There were also closeups of jewelry, handbags, evening sandals, handkerchiefs and similar small accessories.

Although the demonstration had been publicised in advance as being about to prove the practicality of television for spot news pick-ups, such was not the case. Advance statements emanating from a prominent motion picture make-up man indicated that television would eschew the purple lipstick, green rouge and blue powder generally believed necessary. While it may do so in the future, it did not

do so at the fashion broadcast. The expert had said, "Television performers will wear natural make-up, and probably less of it than the average New York woman uses for street wear." Yet in the fashion broadcast a succession of short scenes showed that the usual orange shades of lipstick were too light to be effective; dark reddish brown or dark purplish red had to be used. Similarly standard eye shadows failed to reproduce correctly and brown had to be applied over it. The make-up is not altogether unlike that used for motion picture work. However it is only fair to state that the expert who made the make-up predictions may have been envisioning a day in the more remote future.

## CONCLUSIONS

The demonstration was, nevertheless, an unqualified success. It proved that television carries images with sufficient detail to enable fashion features to be seen clearly in the receiving apparatus. Lookers-in saw negligees which ranged from one-color silk and satin robes to dark plaid and plain color wool, and found that they could distinguish patterns easily, materials not so readily. They saw furs and could distinguish many types, silver fox being especially striking. They saw sports dresses and noted the decorative details. A running commentary was given by NBC's "fashion editor" and an announcer.

"Eventually," remarked Lenox R. Lohr, president of  
*(Continued on page 490)*

## LET'S PEEK IN AT TELEVISION WITH TWO OF ITS LEADERS

Problems of American television are discussed by Dr. Goldsmith, RCA consultant.

British and American television systems are compared by the president of RCA.

By DR. ALFRED N. GOLDSMITH

By DAVID SARNOFF



**R**ESIDENTS of New Jersey will have front row seats in the theatre of the air" when television becomes a public service.

In the northern part of the state particularly, experimental field tests have shown reception conditions often as good as those met with in many parts of metropolitan New York, where the RCA transmitting station is located, in the Empire State Building. New York presents problems in television transmission that are unique, because of the effect of tall steel structures on the ultra-short radio waves employed in the new art. However, communities in northern New Jersey are said to be lucky in that so many points are in direct air line with the television transmitting antenna on top of the Empire State Tower, because this is the ideal condition for reception of ultra-short waves.

*(Continued on page 496)*

**D**URING MY 5 WEEKS stay abroad, I studied the latest developments of television in Europe. While interest is shown everywhere in this new branch of the radio art, greater progress has been made in England, than elsewhere in Europe.

Nevertheless, the experience to date with television in England, has only served to emphasize the formidable nature of the problems which must be solved before a satisfactory service of television to the public can be rendered, and a new industry soundly established.

## AMERICAN VERSUS BRITISH TELEVISION

The question is often asked: "Is England ahead of the United States in television?" I shall try to answer this question by stating the facts as I have now observed them on both sides of the Atlantic.

*(Continued on page 495)*





# PUSHBUTTON TUNING

Twirling a dial to tune stations is definitely on the way out;—making way for automatic push-button tuning systems here described.

N. H. LESSEM

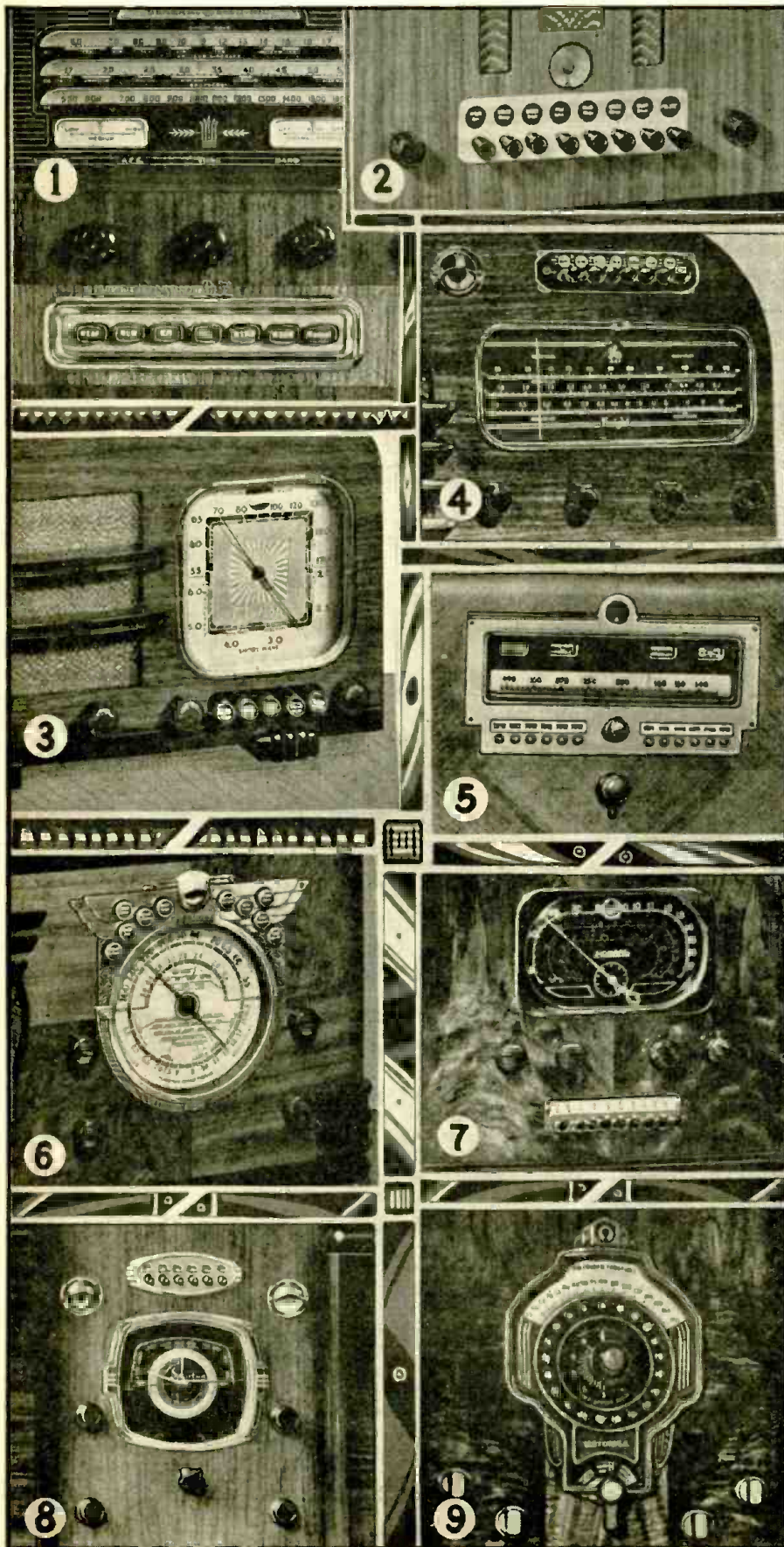

EVER SINCE the introduction of "single-dial tuning" more than a decade ago, manufacturers, experimenters and engineers have endeavored to develop systems for automatically tuning radio receivers. A number of years ago several manufacturers actually placed on the market "remote tuning" receivers, the mechanisms of which were almost identical with that of some of the modern *pushbutton automatic tuning receivers* illustrated on these pages. A small electric motor, in conjunction with a 2-segment commutator switch, was utilized to rotate the ganged variable tuning condenser. In order to tune a station one had to press (and keep depressed) one of several pushbuttons which were pre-set and marked for a given station, until that station was heard; or instead of pushbuttons, other systems would require a selector switch to be rotated to the desired station (indicated on the head of the remote control unit).

The only trouble was that the stations were hardly ever tuned-in exactly right, due to the fact that the motor (for any given station) would never stop at the same identical spot twice. This of course impaired the tone quality appreciably. Had *automatic frequency control* been known and utilized at that time, these systems would have worked fine and dandy, since then, slight detuning of the ganged condenser would automatically have been compensated for (in superheterodynes) by a shift in frequency of the local oscillation.

Today's pushbutton automatic tuning receivers employ one of 2 separate systems. One, as mentioned above, using a *motor-driven variable condenser* with A.F.C. compensation; and, the other using *trimmer-condensers*, in place of variable gang condenser tuning, switched into the circuit by means of pushbutton switches. This latter system does not require A.F.C. compensation although this is a desirable feature.

Incidentally, even trimmer-condenser tuning systems are by no means new. As far back as October, 1935 the writer wrote an article in *Radio-Craft* on the construction of a "Lazyman 4 Receiver," in which toggle switches were used in place of pushbuttons to tune-in separate stations. In this receiver, 6 pairs of trimmers (after being pre-set for definite stations) could be "cut" into the circuit by means of these toggle switches.

Following are the characteristics of the modern pushbutton tuning receivers illustrated on these pages. The numbers



# REPLACES DIAL TWISTING

preceding each description correspond with the numbers on the illustrations.

**1 G. E. "Touch-Tuning" System.** Employs 6 pairs of selector trimmers to tune the antenna and oscillator circuits to 6 different stations in the broadcast band. The gang condenser must be set to a station not tuned by the selector trimmers. Pressing any one of the buttons releases any other button which may have been depressed. Each button covers a definite frequency range and any station within that range may be set to be tuned by that button. Touch-tuning is instantaneous. An A.F.C. circuit compensates for slight misalignment of the selector trimmers.

**2 Howard Radio Company Pushbutton Tuning.** Two systems employed, namely, one whereby individual trimmer condensers are "cut" into the circuit by the pushbutton (entirely replacing the gang condenser); and another in which a motor is used to turn the variable condenser. Eight buttons are available for 8 pre-set stations, each button covering a definite frequency range. Note that no tuning dial whatever is used in this model. An interesting feature of the receiver is that one of the buttons may be used for any police band station. The motor-tuned receiver is illustrated in photo No. 7. In these models the dial pointer travels directly to the station desired. It does not (as with some of the other systems), move across the entire dial to a reversing point and then travel back to the point of the chosen station.

**3 Clarion Corporation "Flash-Tuning".** Trimmer condenser tuning system permits 6 stations to be chosen. Depressing the buttons "cuts" pre-set trimmer condenser into the tuning circuit, in place of the usual variable condenser. In the rear of the receiver 2 sets of buttons for each station adjust these trimmers for any of the stations within the prescribed frequency range of each tuning button.

**4 Knight (Selectronic) Pushbutton Tuning.** This system uses a motor-driven variable condenser. An A.F.C. circuit compensates for slight off-tune settings. Nine favorite stations may be pre-set and selected at will by merely pressing their respective buttons. Another system uses 7 pushbuttons with corresponding trimmer condensers in place of the variable condenser; A.F.C. is used.

**5 Majestic Radio and Television Company.** Motor-driven automatic tuning with A.F.C. compensation. Provides for 12 stations which may be easily pre-set from the front panel.

**6 Detrola Radio and Television Corporation.** Motor-driven automatic tuning with provision for 10 stations. A special feature is that manual tuning can be had without the necessity of throwing any switches.

(Continued on page 498)

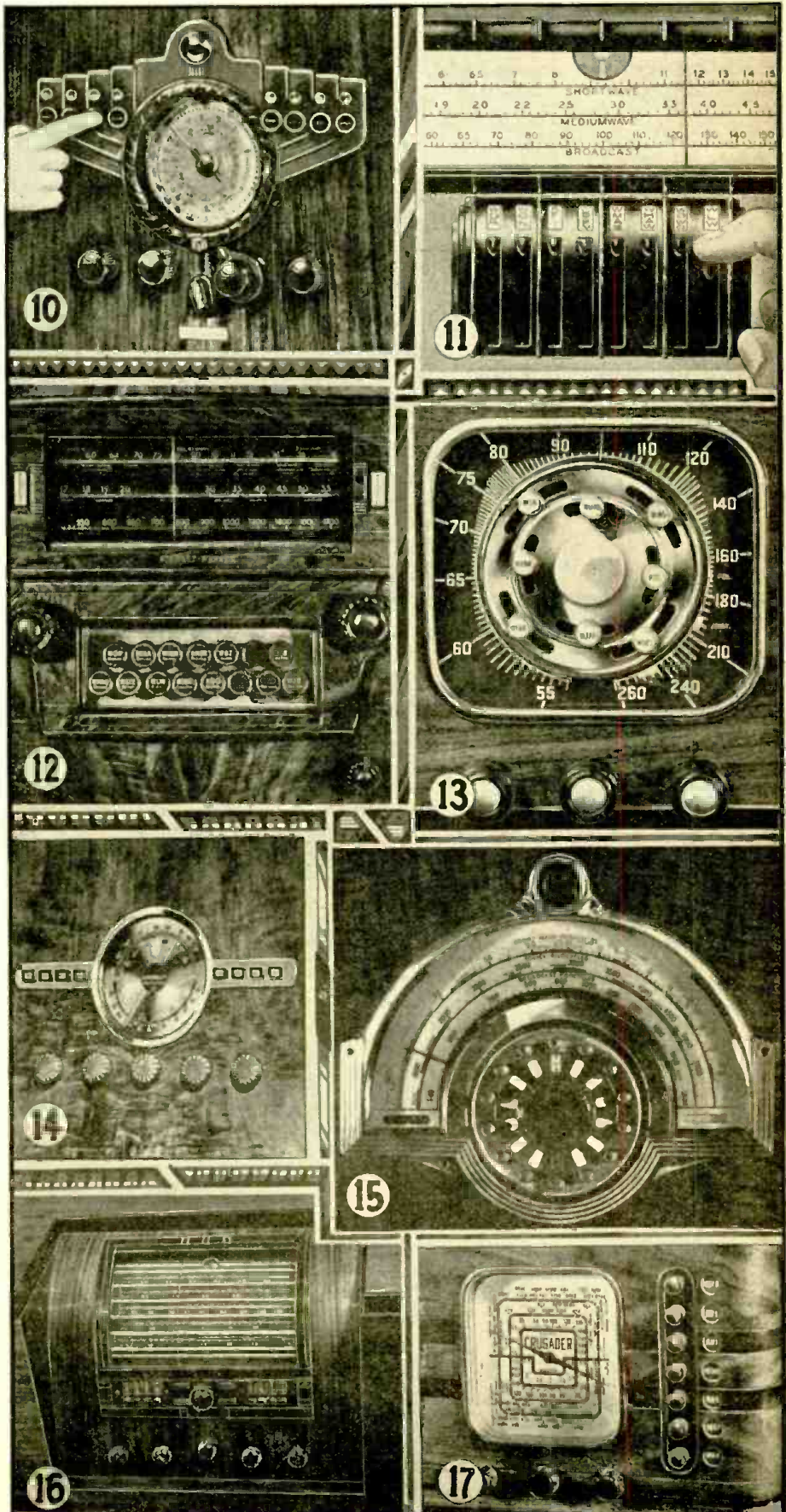



# THE RADIO CLUB CHAIR!



**1 SOLITAIRE WITH ALL THE TRIMMINGS!**—cigarettes, radio, telephone, overhead lighting, everything the heart desires,—close to hand. This Radio Club Chair, which contains everything but the kitchen sink, is so made you won't have to get up from the chair once you have sat down.



**2 NOW IT'S COCKTAIL HOUR!**—and still you don't have to get up. The left side of the chair opens to reveal all the necessary paraphernalia for mixing drinks. A loudspeaker hidden in the back of the chair affords the musical accompaniment.



**3 SHAVE, MISTER?**—Reach into the left-hand arm compartment for electric razor and mirror, and plug the former into the convenient outlet mounted in back of the chair. Notice the magazine rack built into the side of the chair. A fellow can make a career of sitting in this chair.

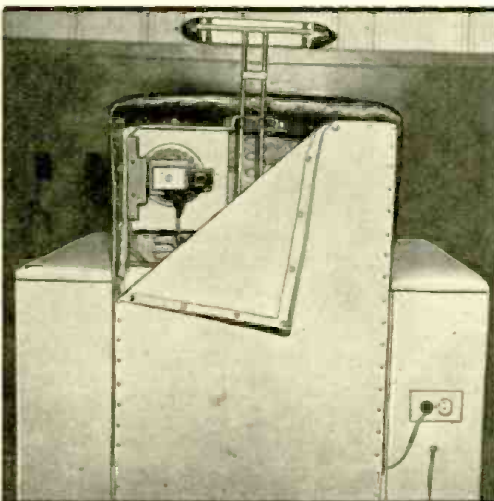

**4 THE VOICE OF COMFORT!** Rear view of the "radio club chair" showing the loudspeaker installation and the convenient electric outlet. Notice the clever arrangement of the overhead light, which can be adjusted to any desired height. The cover is easily removable for convenient servicing. *Imagine staging a sit-down strike in this chair!*

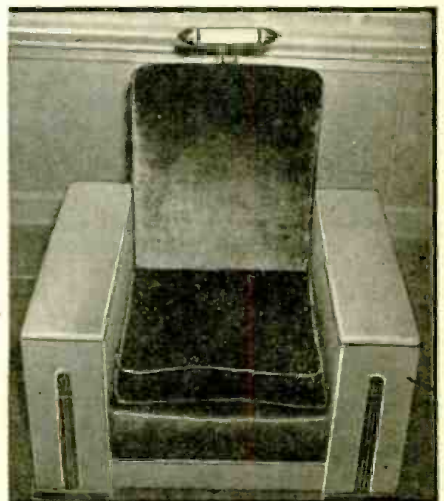

**5 THE LAZY MAN'S THRONE!** Would you think, merely by looking at it, that this chair contains, in its various hidden compartments, all the necessary paraphernalia for putting on a sitting endurance contest? If only it had hot and cold running water and a bathtub it would be complete.

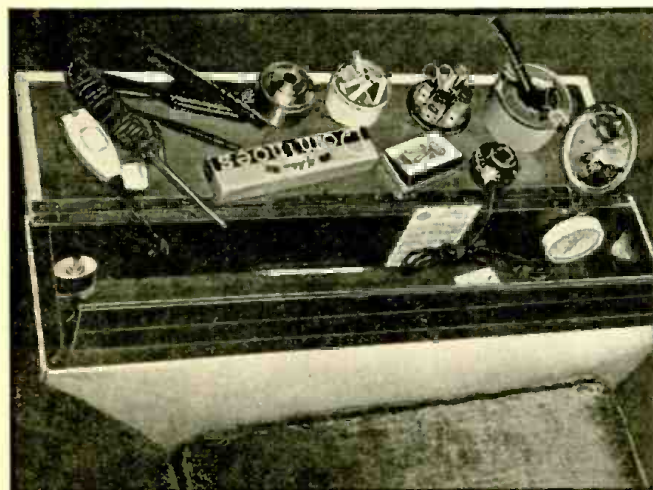

**6 LITTLE THINGS FOR BIG COMFORT!** Electric razor and curling iron, cigarettes, electric cigar lighter, pipe and tobacco, mirror, thermometer, manicure outfit, playing cards—practically nothing missing for which anyone would bother to get up—all contained in the left-hand arm compartment. Inventor George Turney hails from Houston, Tex.

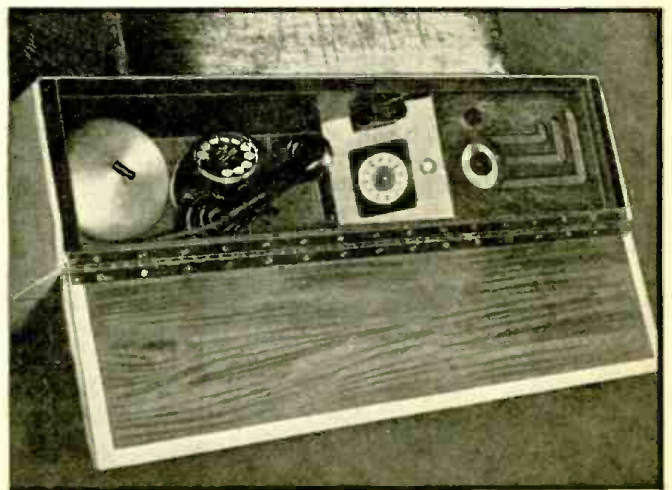

**7 MORE CONVENIENCES!**—this in the right-hand arm compartment. Telephone, electric clock, conventional midget receiver and what appears to be either a tobacco humidor or a huge powder box. Everything seems to be designed to make the lazy individual even lazier. What is there left to induce a man to vacate such a chair?



# NEW CONDENSERLESS TUNING SYSTEM DEMONSTRATED!

An old system of tuning, but with the refinements of modern discoveries and technique—this system shows signs of being universally adopted in place of "variable-condenser" tuning.

W. E. SHRAGE

**A** N OLDTIMER of radio communication, Paul Ware, demonstrated last month at a meeting of the Radio Club of America a modified tuning system—equipped with coils of variable inductivity—which he believes will cause great changes in present all-wave receiver design.

## "FIXED C/VARIABLE L" TUNING

Modern radio engineers consider it old-fashioned to design tuning circuits with a *fixed condenser* but with a *variable inductance*; that is, with "fixed C/variable L". Instead, it is customary, today, when developing new circuits, to think in terms of (a) *variable capacity* and (b) a *fixed inductance*; that is, variable C/fixed L.

Although it is true that the fixed C/variable L method of tuning is exceedingly antique, having been known almost since the beginning of radio communication, it should not be considered as being a tuning system having poor electrical efficiency. In fact, the contrary is true. The electrical qualities of this design are often much better than those of present-day tuning circuits—operating with a variable condenser but a fixed coil—and the main attraction of this "old-fashioned" method of tuning is the well-known fact that it *permits covering large frequency bands without need of switching*.

Nevertheless, any time the problem comes up to use *variable contacts* on coils (in order to vary the inductance value), many a radio engineer is inclined to discard this idea, and tends to achieve the effect desired by means of a variable condenser.

However, these designers forget that metallurgists and chemists have made great strides in the past few years in achieving new alloys, and in the treating of metallic surfaces. This new knowledge about metals permits the manufacture of switches and contacts, which not only operate noiselessly, but also provides perfect contact over long periods of use.

## FUNDAMENTAL PRINCIPLES

It does not need mention that the ultimate trick of Mr. Ware's new tuning device lies with the ingeniously designed method of contact. Before going deeper into the matter of contact, let us first look at Fig. 1B which presents the fundamental circuit utilized. The variable coil  $L_v$  (which may be rotated in either direction) is connected with the end-coil  $L_e$ , and with a padding condenser  $P$  which is used to align the coils if a set of them is used. The small end-coil  $L_e$  has been applied in order to shift the dangerzone of natural frequency of the tuning coil  $L_v$ —outside the tuning range.

All that is required to tune this circuit is to move the contact  $C_t$ , and this contact  $C_t$  will short-circuit (in accordance to its position) a more or less large part of the main-coil  $L_v$ .

## TROLLEY CONTACT REPLACES SLIDER

Now let us see how the important problem with the perfect contact has been solved. The familiar type of slider-contact (uniformly used in the dear old days of detector reception) has of course been discarded. Instead of the earlier type of

*(Continued on page 491)*

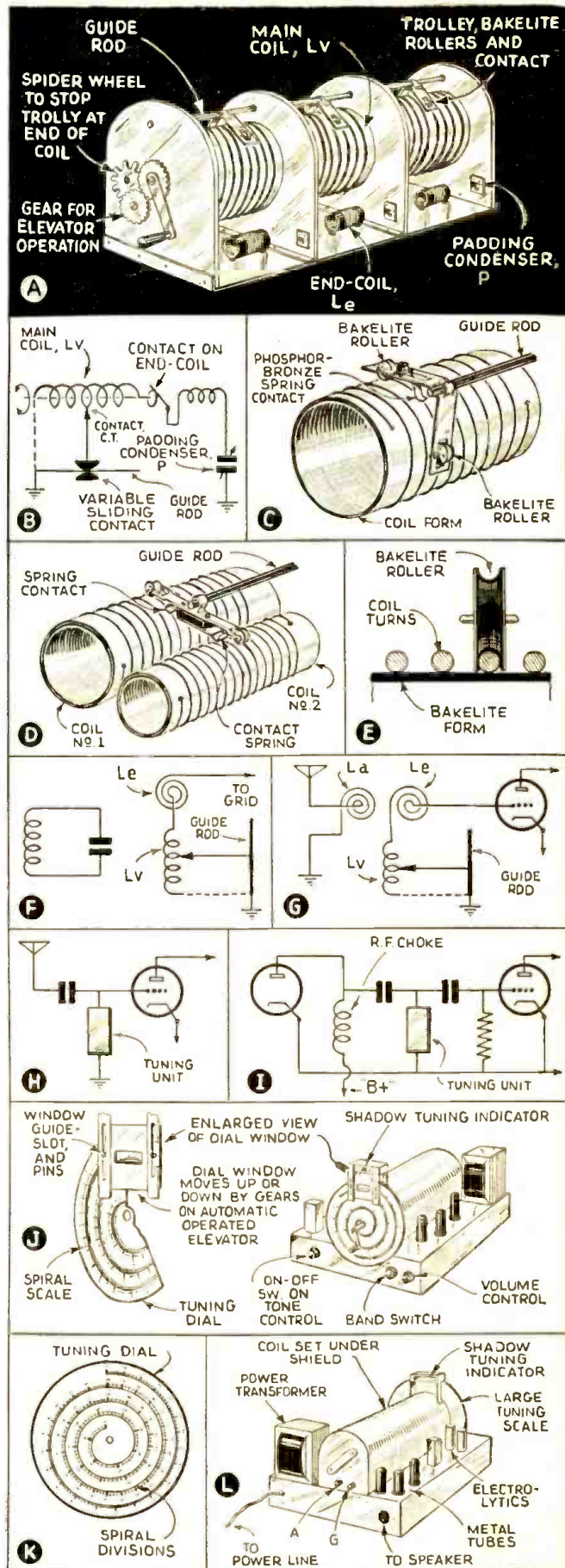
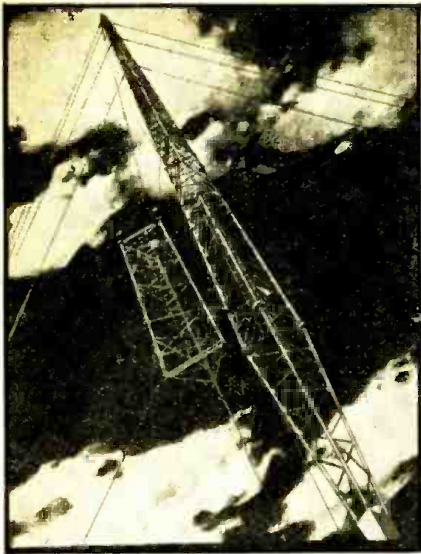

Fig. 1. Fundamental detail sketches and circuits of the "variable-inductance" tuning system. Although the underlying principle is old, the present system of application may prove revolutionary.





Reproduction of cover painting.

## 60 TONS OF ANTENNA

The world's tallest of slim-welded structures is completely insulated from the earth. Nevertheless lightning crashes to ground from it without affecting broadcast programs!

what is claimed to be the world's most modern and efficient antenna, a 718 ft. steel "cloudscraper" located at Saxonburg, Pennsylvania, which is now giving primary service for an area 10 times greater than that formerly provided with strong clear signals.

The new antenna, like the other modern equipment in KDKA's present spacious quarters, signalizes the amazing advances made by radio in 17 brief years. It was November 2, 1920 that the original KDKA, housed—studio, sending equipment, technicians and talent, altogether—in one big room at the Westinghouse Headquarters Works in East Pittsburgh, flashed to the owners of the few amateur receiving sets then in existence the news of Warren G. Harding's election. That daring venture inaugurated a daily program which marked the beginning of commercial radio broadcasting.

In 17 years, broadcasting stations have multiplied the original one into  
(Continued on page 493)

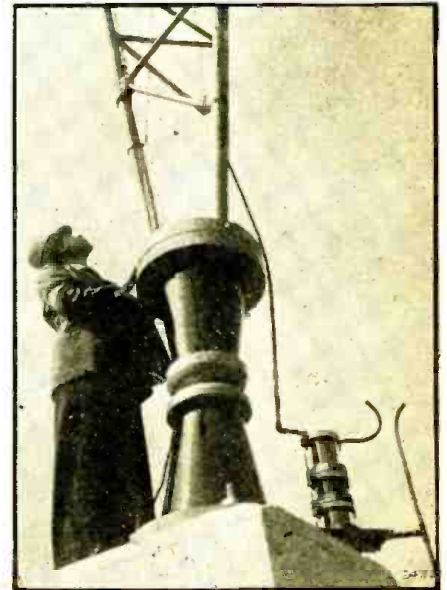

Though weighing 60 tons and towering 718 feet, the antenna rests on a single, 18-inch diameter porcelain insulator. Note lightning horn-gap at right.

**T**O ESKIMOS who like almost everyone else, heard their first radio broadcasts from KDKA, those call letters still are synonymous with broadcasting itself. Recently, radio listeners in every clime shared the Eskimos' sentiments, for the entire radio industry joined to celebrate the 17th anniversary of that pioneer broadcasting station. (See January *Radio-Craft*, pg. 391, "New Antenna to Multiply Field.")

### NEW 3/4-WAVE "CLOUDSCRAPER"

Significantly enough, the high point of the ceremonies was the dedication of

## TELEVISION STUDENTS LEARN BY MAKING CATHODE-RAY TUBES

### PART IV

Readers of *Radio-Craft* have exhibited exceptional interest in this series of articles—published here for the first time in any popular radio magazine — on constructing experimental C.-R. tubes for television.

U. A. SANABRIA

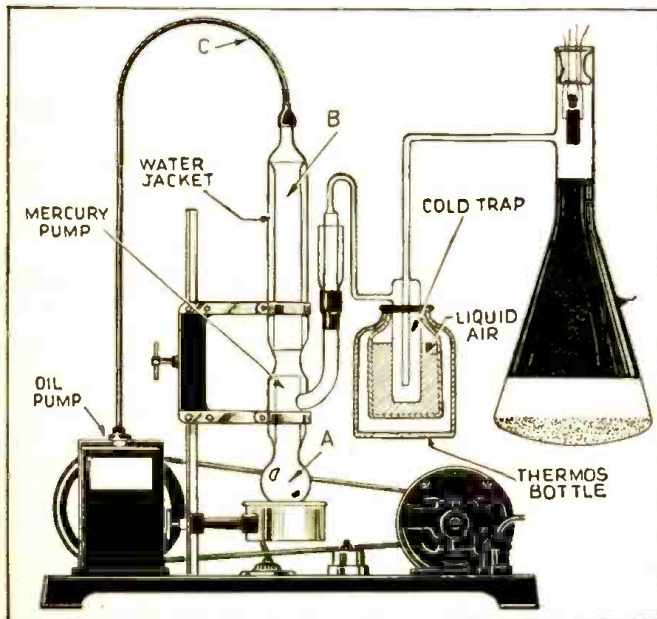

Fig. 2. The set-up used to evacuate the cathode-ray tube. An oil pump, mercury pump, electric heater, and cold trap are utilized.

**I**N THE PRECEDING installments we described the mechanics of fusing the fluorescent screen to the inside surface of our cathode-ray tube as well as applying an internal graphite coating. We now come to the description of the *electron gun* construction as well as the procedure for evacuating the tube.

(The final design of the electron gun will be discussed in another installment. The one described here is one of many designs with which we experimented before evolving the final one.)

### CONSTRUCTION OF THE ELECTRON GUN

A *nickel sleeve* is tipped with a mixture of *barium and strontium carbonate* (made by a well-known chemical firm and called "Radio Mixture No. 1"). *Amylacetate* is used as a *binder* material together with a very small amount of *collodion*.

Only the end of this cylinder, which is short, is coated with this mixture. When the sleeve is heated to a bright red heat the mixture combines with the nickel to form what is known as an *oxide filament*. This combination constitutes a very copious emitter of electrons and is far better for this purpose than either tungsten or thoriated tungsten.

In the center of this sleeve is placed a tungsten heater element (A, in Fig. 3). The tungsten heater is the filament which heats up the nickel sleeve (B) or cathode. Over this

(Continued on page 492)



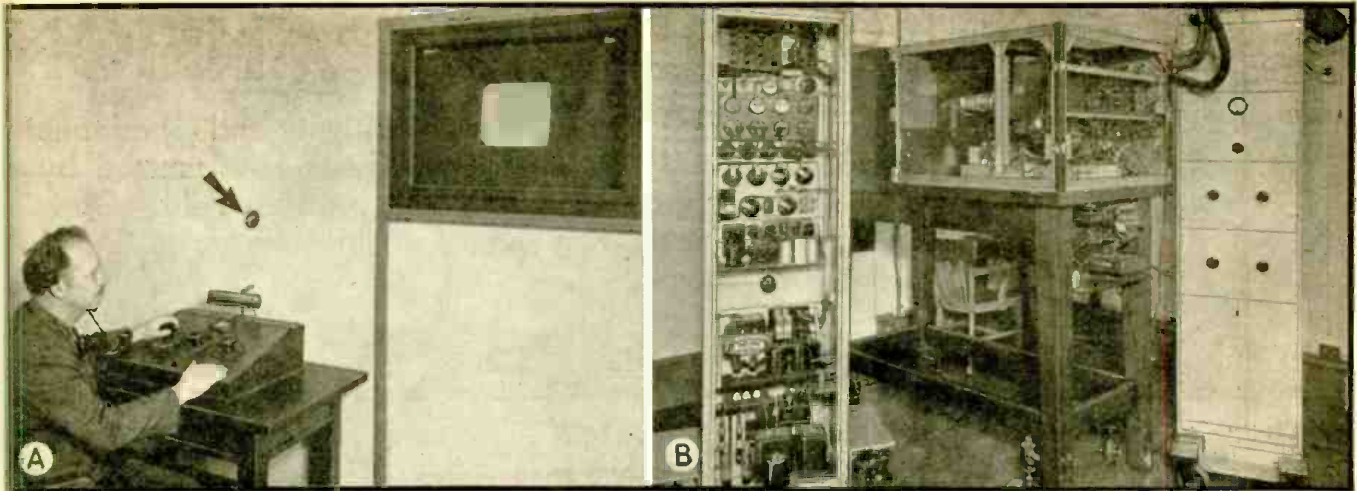

At A the cathode-ray screen and the control desk; and at B the equipment in an adjacent room showing the rear of the C.-R. tube, its power supply (left) and sweep circuit (right). Arrow (A) points to telescope used by second monitor (on other side of wall) to view C.-R. tube's image as reflected in a mirror.

"Single-sideband" image-transmission, over the New York to Philadelphia coaxial cable, affords better than 240-line fidelity, states Mr. Jewett, President of Bell Telephone Labs., in a release (reproduced below).

## TELEVISION "PIPED" 100 MILES

FRANK B. JEWETT

**R**ECENTLY, in the Bell Telephone Laboratories in New York, a sound-picture film was run through a transmitter and the film's two records — sound and scene — now converted into electric currents, were "piped" (transmitted) over the new "coaxial cable" to Philadelphia. (See Radio-Craft, April 1935, page 583; and August 1935, page 70.) There, the picture was reproduced on the screen of a cathode-ray tube, large enough for a group of 10 people to see easily while the accompanying sound came from a loud-speaker. The sound pictures described, by voice and animated diagrams, the coaxial cable system (in which one conductor, in the form of a tube, completely surrounds a second conductor) and explained briefly the operation of the picture transmitter and receiver. Some films, typical of the newsreel theatre, were also transmitted.—Editor

In order properly to appraise this demonstration of television pictures transmitted (as images) over the coaxial cable, it is necessary to understand just what the demonstration was designed to show; what it was and was not; and what was new and an advance over the preceding art.

The demonstration was *not* the first transmission of tele-

vision-image currents for long distances over wires. The first such demonstration was made by the Bell System in 1927 when television image currents were transmitted from Washington to Bell Telephone Laboratories in New York and there reproduced. In that demonstration transmission was over specially-conditioned telephone circuits of ordinary construction. The characteristics of such circuits were sufficiently good for the poor grade of television picture then attainable by the equipment for scanning and reproducing (50 lines, corresponding to a frequency bandwidth of approximately 22,500 cycles).

The demonstration was *not* one designed to show an improved television per se. In fact the images (240 lines) were inferior in grain to those produced by the most modern television equipment (441 lines or better). This was not due to any limitation imposed by the scanning or reproducing apparatus but to the limitations imposed by the experimental *terminal* and *repeater* equipment now on the New York-Philadelphia cable. This equipment limits the top frequency of the transmitted current to approximately 1,000,000 cycles so that a 240-line picture is about the finest-grain image that can be transmitted. (Continued on page 497)

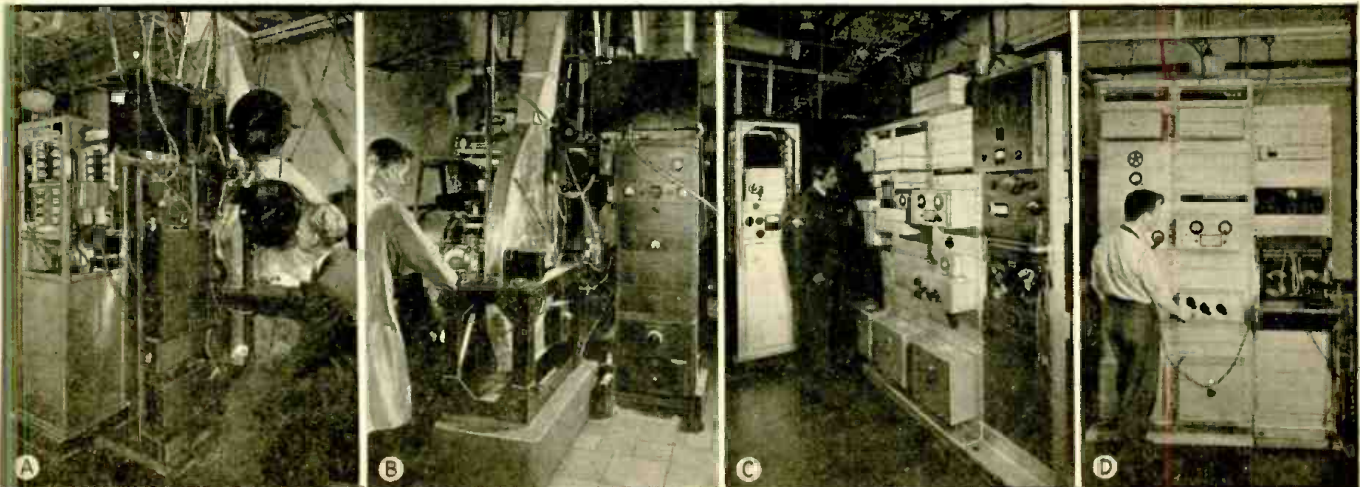

These photographs show some of the elaborate equipment used for the television demonstration. In A, converting the sound-picture film into electrical impulses by means of the huge lens scanning disc shown in B. In C is shown some of the filters, equalizers and amplifiers which prepare the signal for transmission over the coaxial cable; and, at D, the carrier-current equipment at the Philadelphia terminal of the coaxial cable.



# VOLUME EXPANSION

Problems of (1) microphonics, (2) fidelity and (3) adequate expansion, and their recent solutions are discussed by a well-known specialist in the Public Address field. Certain disc recordings having special significance for testing purposes are mentioned.

CLIFFORD E. DENTON

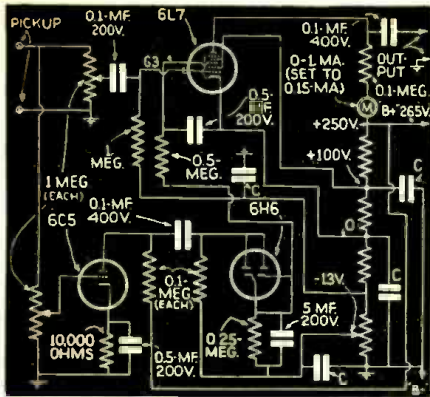

Fig. 1. Injector-grid bias controls expansion.

**T**HE VOLUME EXPANDER was introduced in 1935 as a means of improving electrical phonograph reproduction. Due, however, to either a lack of appreciation of its possibilities or lack of interest on the part of the public in recordings, the development of this interesting device was confined to the work of a few designers. The year 1936 saw the phonograph record business soar to new highs in sales and with this favorable impulse the interest in expansion increased just when it had been threatened with oblivion.

The original circuit was described by RCA and is shown in Fig. 1. In operation the 6L7 is used as an audio amplifier whose gain can be controlled by variation of the injector-grid bias. A separate amplifier and rectifier supply this control voltage.

## FIDELITY INCREASES WITH EXPANSION

A study of the curves in Fig. 2 will show how the gain of the tube can be varied as the voltage on the injector-grid (G3) is changed. While the curves in the figure are only *relative* it is interesting to note that the distortion is greatest at low percentages of expansion; and decreases as the expansion is increased.

The control-grid of the 6L7 is biased through the voltage divider. This section of the tube has a remote cut-off characteristic and for this reason some means of limiting the signal input to this grid must be used if distortion is to be avoided. The injector-grid is biased more negatively by means of the potentiometer. This makes the injector-grid more negative than the cathode with the result that the gain (plate transconductance) is low. See Fig. 2. The same signal is fed to the control-grid of the 6L7 and to the control-grid of the 6C5 expander amplifier. The output of the 6C5 is rectified by the 6H6 and this voltage is applied to the injector-grid (G3) in such a manner that the high starting negative bias is reduced with a resulting increase in transconductance or gain. This increase in gain is approximately proportional to the rectified voltage developed by the diode so that any increase in signal amplitude from the record will proportionately expand the output.

Volume expansion has a definite place in audio work. Let us see just *how* it can work for us to advantage.

## TESTING FOR EXPANSION

A milliammeter placed in series with the plate load resistor will indicate the change in tube dynamic characteristics when expanding. With the starting current set for 0.14-ma. (no signal) by adjustment of the bias on G3, play a record and note that the plate current will rise to 0.5- to 0.7-ma. on loud record passages. In fact, the meter pointer will vary along with the reproduction and will indicate the presence of expansion without listening to the loudspeaker. The inclusion of a 0-1. ma. meter in the expander amplifier is a convenience as it simplifies the selection of 6L7 tubes for satisfactory performance and permits the accurate setting of the 6L7's plate current for operation as an amplifier without expansion. When the tube is used as a straight amplifier set the plate current to 0.3-ma. and then turn the moving arm of the expander amplifier potentiometer to the ground side. This will set the gain of the 6L7 at a higher level than that used with expansion and will block off any signal through the expander amplifier.

Those who have built amplifiers using this circuit have found that 6L7 is very critical and subject to microphonics. The *divider method* of obtaining the various tube voltages required high values of capacity to prevent inter-coupling between the following stages of the amplifier. In the attempt to "cure" microphonics the tube has been slung on floating sockets and in some cases completely enclosed in heavy shields to minimize acoustic coupling between the tube and the loudspeaker. *Most of the methods of floating and shielding were ineffective to say the least; so, a new electrical version of the circuit was developed.* This circuit—WHICH HELPED SOLVE THE "MICROPHONICS" PROBLEM—is shown in Fig. 3.

## REDUCING MICROPHONICS

This refinement of the 6L7 expander includes the use of a 6C8G, one of the newer dual triode tubes as a combination expander amplifier and rectifier tube. The diode anode consists of the grid and plate of one of the tube sections connected together.

The plate load of the 6L7 is 20,000 ohms and while the gain from the stage is lowered there is a great improvement in performance, particularly as far as microphonics

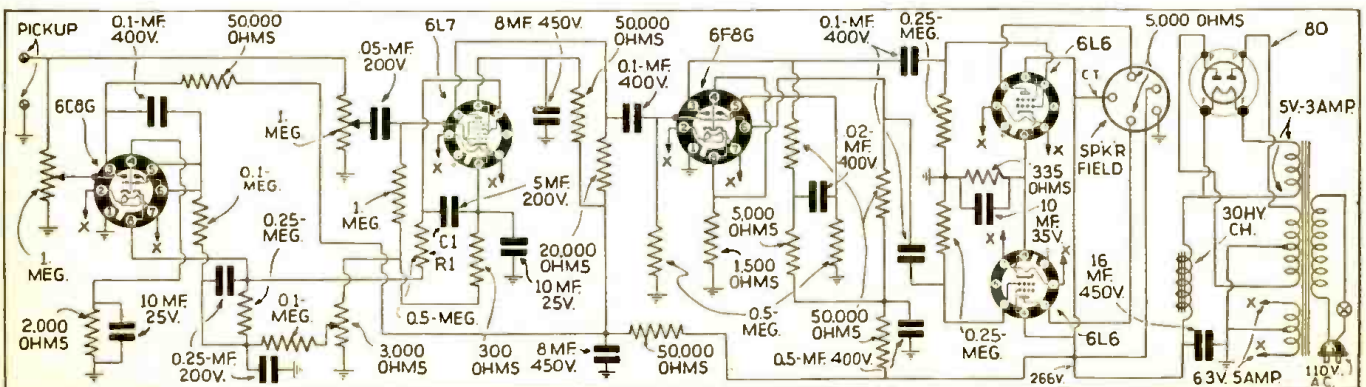

Fig. 3. By utilizing a type 6C8C tube the problem of microphonics is solved.







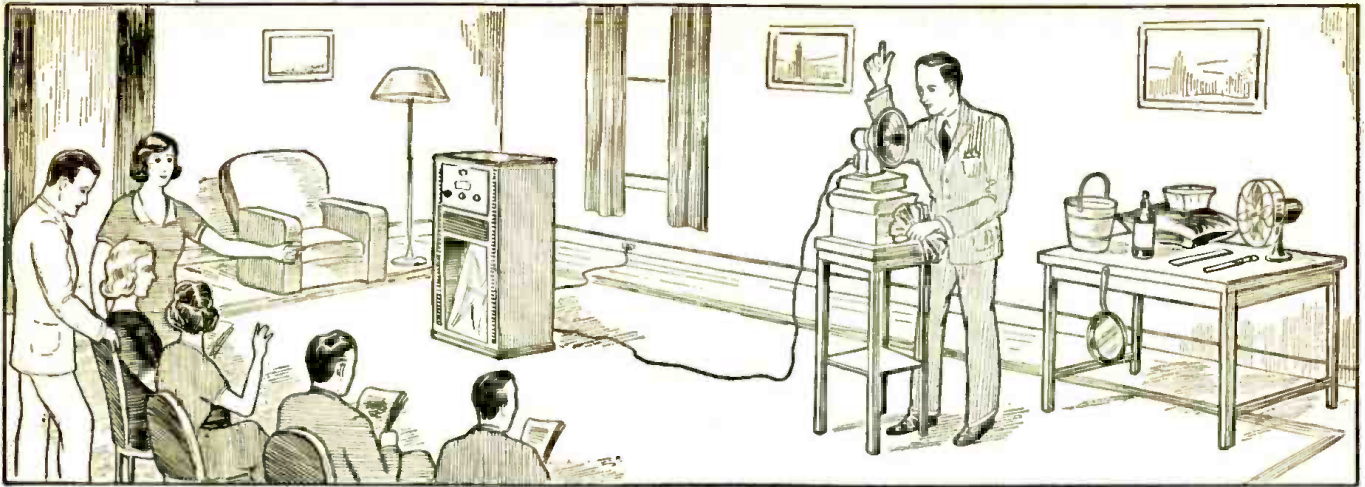

Fig. 1. The "stage" set-up for putting on the home broadcast program. The "mike" and sound-effects table may be located in another room if desired.

# HOW TO STAGE A HOME BROADCAST

Latent talent for broadcasting may be discovered by staging your own programs. Here you learn, via a burlesqued home-broadcast, the rudiments of "getting on the air."

ROBERT EICHBERG

**L**ISTENING TO A BROADCAST probably ranks third in respect to fun, as far as the B.C.L. (broadcast listener) is concerned. Second, is being a member of the studio audience; and first, is being an actual participant in the performance.

You can give your guests all 3 thrills by the use of a home broadcasting "mike," a few sound effects and—a little ingenuity!

## TECHNICAL PRELIMINARIES

The microphone, or "mike," may be one of the sort that can be bought in most radio stores for 25c to \$2.50. These normally come with instructions for connection to average types of radio sets. Failing that, the "mike" may be a loud-speaker of either the magnetic, permanent-magnet dynamic or crystal type. It is ordinarily connected between the grid of the detector tube (2nd-detector, in a superhet.) and the ground, as shown in Fig. 7. (The set-chassis usually is ground.) Connecting a short wire (with a condenser of about 0.006-mf. capacity in series) from the antenna post of the set to the chassis will usually keep the regular radio stations from competing with you when you stage your own program.

Probably your set will howl like a soul in purgatory when you first try this out. Don't let it bother you; it is a good

sign, showing that you have ample "gain," or amplification. You can overcome the howl by placing the mike well off to one side of the set, and slightly to the rear of it. Sometimes it may be necessary to put a box-top draped with a Turkish towel near the mike, between it and the set, to screen out the sound waves which result in feedback. See Fig. 1.

If your friends are talented instrumentalists, or if the party has reached the "Sweet Ad-o-line, My Ad-o-line" stage, there will not be much to staging your own amateur hour, provided the accompanist has brought his piano. But far more fun is had by putting on a dramatic program, which gives almost everybody a turn at doing a little plain and fancy emoting. It is especially amusing if the program is based upon some standard broadcast, burlesquing it a bit. You might even combine 3 or 4 popular programs; suggestions on how to do this will be given further on in this article.

Having everything in readiness, you are ready to begin. Someone (and it had better be you) will have to act as program manager, studio director and production man. Arrange the seats as you want them, type out the parts for your cast, and let them all sit right in the "studio". They can leap from their seats to take part in the show, returning

(Continued on page 489)

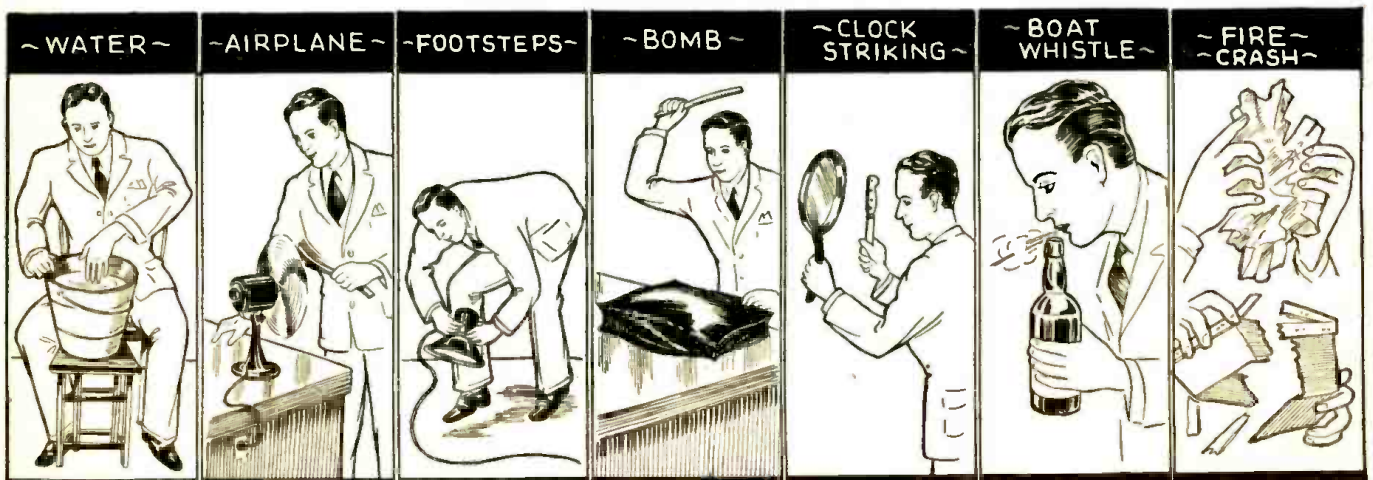

Fig. 2. With the aid of simple, easily-obtainable apparatus, sound effects which are quite realistic may be obtained. Read text for other effects.



By permission, of the British Broadcasting Corporation, *Radio-Craft* reproduces and describes views in the B.B.C. Effects Studio. U.S. effects, too, are mentioned.

# SOUND EFFECTS —THE BRITISH WAY



**GHOSTS WALK, WHILE BANSHEES SHRIEK AND SOUND-EFFECTS MEN PERSPIRE**, for here they are at the sound-effects table, giving British listeners all the thrills of a haunted house. The clanking chains are seen manipulated in the hands of the very-much-alive gentleman at the right, while his fellow-spook holds a piece of screeching brass against a whirling grindstone. Another good goblin gadget, not shown, is the *bullroarer*, made by fastening a raw-hide thong to the bottom of a small drum, and pulling the thong through a resined chamois skin. The throaty howls emitted may be as terrifying as one likes, and are frequently used inside the "Wild Man's" tent, to cozen the suckers into thinking they will really see something, and thus persuading them to part with their sixpence. An American ghost, if he has become a radio performer, also uses the chains, but adds the refinement of rattling his bones, too, as he waits around the studio. He does not rattle the bones as in a dicing main (craps to you) but has a special effect, consisting of a number of small hardwood pegs, loosely strung together, so that they rattle when shaken. However, the only time the ghost walks around most American studios is on payday, United States listeners having an inherent disability to respect a specter, and a habit of confounding ghosts with goats.



**A SIREN OF THE SEAS, NEITHER A MERMAID NOR A CRUISE PASSENGER**, is the effect for which this young man is striving. Above and at the center of the cluster of compressed-air tanks he has a steamer whistle, connected by a tube to the tank which he is manipulating. He pulls the lever twice slowly, twice rapidly and the siren whistle emits a loud Whoo-whoow-whoow, after which he can go home to his tea and crumpets. The tanks behind the one he is using are spares, but the two at the left are ready to use for other effects. The one at the left-rear is a whistle of higher pitch; the one at the left-front bears a 3-toned whistle. Much easier is the system generally adopted by many major United States stations, which use recordings. The apparatus is more compact; there is room for a wider variety of effects in the studio and in the "props" room where effects are stored. Instead of having to have a half-dozen tanks with an assortment of whistles, like our British brethren, *American sound-effects men simply pull the right record from the rack, put it on the turntable and place the pickup as needed.* Many records carry several sections each, so that one may have the sort of whistle a boat emits when departing, when arriving, when calling for a pilot, when fog-bound (ah, there, London), or when warning a fisherman to look out.



**HEAVEN HELP THE SAILORS ON A NIGHT LIKE THIS**, when 5 sound-effects technicians unite their efforts to make life miserable for the fo'c's'l hands on a windjammer. The men at the right are not holding a bass drum; it is a tightly stretched membrane, however, that is much like a half a bass drum. The man in the foreground is gathering up a handful of sand, which he will hurl upon the tissue paper in the basket before him—that sounds like a smother of spray coming over the good ship *Sylvia's* bows. The murmur of the surf will be imitated by rocking the half-drum, causing the sand on the membrane to slide back and forth in a rhythmic fashion. The potatoes, also on the membrane, will give the rumble of the storm. The two men holding the long canvas will snap it, to give the effect of the wind slatting the canvas of the sails, and the white square of cloth can be used to augment it when a sharper snap is necessary, or to wipe the brows of the sweating technicians—for this is real work. The only man who may remain still enough to wear a jacket in comfort is the sound-effects supervisor, holding the script at the left as he stands beside the *wind machine*. An excellent wind machine of American type consists of a slatted cylinder. A strip of canvas wrapped around it and fastened to its frame chafes it windily when it is turned.

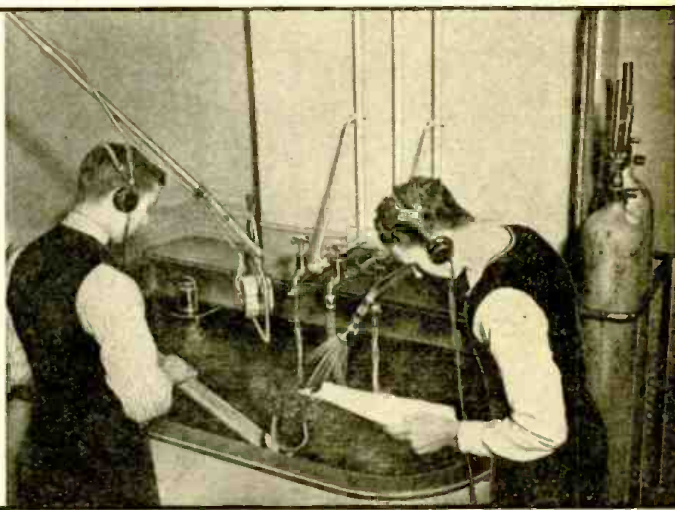

**ROWING IN THE RAIN** is easily indicated. The board in the tub simulates the sound of an oar plashing in a pellucid pool; the oarlock, fastened to the tub's edge may be left unloiled to squeak realistically, or may be silent, clanking but occasionally when the oar is clumsily manipulated—on purpose. The shower head on the right-hand nozzle gives the effect of raindrops striking the water's surface, while the steady flow from the left-hand faucet indicates that the boat is approaching a waterfall. Closely placed, the microphone picks up all these sounds. Notice that both the sound-effects men wear headphones, so that each may judge with what volume to create his effect. Notice also the overflow pipe at the left-rear of the tub; it must be soundless so that it does not gurgle when carrying off the "rain" and "Niagara Falls"; it must be efficient, lest the tub overflow. Many water effects are used in the United States as well, the most famed of which was that of the late lamented *Showboat*, which used a tank only a fraction the size of that employed by the Britfishers. For that effect, a paddle wheel was turned in the small tank, motive power being the sound-effects man's good right arm. The boat's whistle was a 2-tone pipe, lung-operated. Is it any wonder that sound-effects technicians are frequent sufferers from heavy colds?



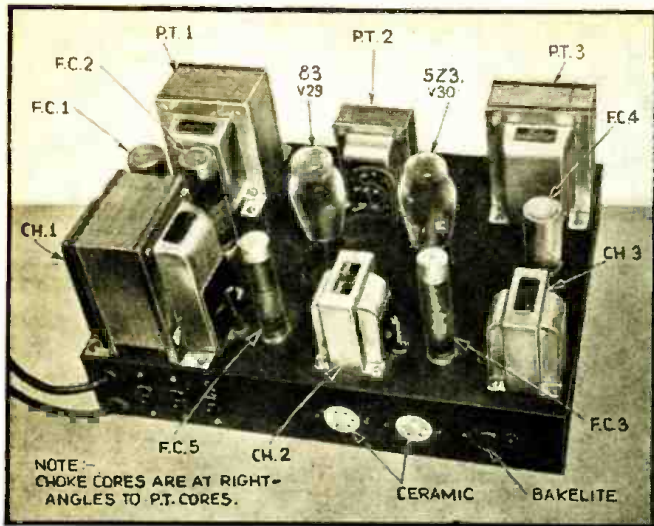

Fig. K. The extra-heavy-duty power supply for the 30-Tube Set. Note the cores of the power transformers and chokes are mounted at right-angles.

# HOW TO MAKE THE RADIO-CRAFT SUPER-DELUXE 30-TUBE SET

In this next to last chapter on constructing the *Radio-Craft* 30-Tube Radio Set is described the final chassis required to complete the actual receiver; the concluding Part, next month, will describe the loudspeaker complement and the rack construction.

## CHASSIS No. 4

### LIST OF PARTS FOR CHASSIS No. 4 (POWER SUPPLY)

- One Stancor power transformer, No. P4024, plate supply, four 6L6, P.T.1;
  - One Stancor power trans. No. P4017, filament supply, four 6L6, one 83 rectifier, P.T.2;
  - One Stancor power trans. No. 4004, plate and filament supply, one 5Z3 rectifier, 14 filaments, 6L6 screen-grids.
  - One Stancor swinging choke, No. C1404, 400 ma., 5 to 25 henries, Ch. 1;
  - Two Stancor filter chokes, No. C1410, 175 ma., 20 hys., Ch.2, Ch.3;
  - \*One chassis, 17 x 13 x 3 ins.;
  - One General Electric 83 rectifier, V29;
  - One General Electric 5Z3 rectifier, V30;
  - Two Aerovox electrolytic condensers, type G6, 475 w. V., 8 mf. F.C.1, F.C.2;
  - Two Aerovox elec. cond. type GLS 5, 450 w. V., 16 mf. F.C.3, F.C.5;
  - One Aerovox elec. cond. type PR 50, 50 w. V., 50 mf. F.C.6;
  - One Aerovox elec. cond. type GLS 5, 450 w. V., 4 mf. F.C.4;
  - \*One wire-wound resistor, 15 watts, 50,000 ohms, B.R.1;
  - \*One wire-wound resistor, 50 watts, 3500 ohms, B.R.2;
  - \*One adjustable wire-wound resistor, 10 watts, 200 ohms total, tap at 64 ohms, B.R.3;
  - Three bakelite wafer sockets, 4-prong;
  - One bakelite wafer socket, 5-prong;
  - \*One ceramic wafer socket, 5 prong;
  - One Cornell-Dubilier dual cond., 400 V., .05-mf., L.C.1, L.C.2;
  - One Cornell-Dubilier tubular cond., 1,000 V., .01-mf., H.V.C.1;
  - \*One ceramic wafer socket, 6 prong;
  - \*Seven terminal connectors;
  - Eight rubber grommets 1/2-in. size;
  - Three A.C. receptacles, flush type;
  - \*One toggle switch, single-pole, 10 ampere capacity;
  - One A.C. line cord, rubber-covered duplex No. 16 wire, with molded rubber cap, 10 ampere capacity;
  - Two R.F. chokes, each 1 millihenry, 500 milliamperes, R.F.C.1, R.F.C.2.
- \*Most Radio mail order houses can supply this item if properly identified as to title of article, issue (month) of *Radio-Craft* and year.

**T**HE POWER SUPPLY for the *Radio-Craft* 30-Tube Radio Set has been designed to give years of dependable service. For this reason all the components are oversize, so that the receiver may be operated hour after hour without overheating. But—and to many people this will be an equally important feature—filament voltage is held to 6.1 volts for increased tube life and lowered operating cost (an appreciable item in a receiver of this size).

Because of the heavy-duty requirements of the parallel push-pull 6L6's a separate source of plate current supply was found to be absolutely necessary for good regulation. The plate current alone of the four 6L6's is 207 milliamperes without any signal applied to the control-grids. This plate current will rise to 304 milliamperes at full output of 60 watts. The measured plate voltage at zero signal was 407 volts and at full output 401 volts, or a drop of only 6 volts between minimum and maximum requirements.

As can be seen, the regulation of current versus voltage is close to being perfect. A further advantage of the separate plate supply is that the 6L6 screen-grid voltage is not affected by the plate current variations. Because the screen-grid voltage remains constant, the fixed-bias for the 6L6 grids is obtained through this supply from a tapped voltage divider arrangement.

As will be noted from the schematic,

shown in Fig. 15C, 3 power transformers are required. The filament transformer, P.T.2, supplies 5 volts at 3 amperes for the type 83 rectifier filament, and also 3.6 amperes at 6 volts for the four 6L6 filaments.

The plate current transformer P.T.1 supplies up to 400 milliamperes at 400 volts with choke input. The remaining power transformer supplies plate, screen-grid and filament power to several tubes, besides being the source of fixed-bias for the 6L6's.

The plate current supply utilizes only one choke to smooth out A.C. ripple to a level below 1 per cent. This choke is of the swinging type and is capable of passing 400 ma. continuously and still have an inductance of 8 henries. At 200 milliamperes, the inductance is over 20 henries. It is a brute for size and weighs over 13 pounds.

The remainder of the plate supply consists of two 600 volt, 8 mf. electrolytics in parallel and a 50,000-ohm bleeder resistor to protect the condensers on the starting surge. The combination plate and filament transformer, P.T.3, uses 2 filter chokes capable of passing 175 milliamperes at 20 henries each. A total current of 125 milliamperes flows continuously through the voltage divider. This transformer supplies filament power for the 5Z3 rectifier and 14 metal tubes on chassis No. 2 and No. 3.

### CONSTRUCTION

The parts should be laid out just as shown in the photographs, Figs. K and L, to avoid hum pick-up. No parts should be permanently fastened to the chassis until all the required holes have been drilled. The sockets should be mounted first. Either rivets or screws and nuts may be used. The light parts should be mounted next and finally the 3 heavy units, that is the 2 large power transformers and the swinging choke. The wiring of the power pack is next. Use only high-grade hookup wire or else use spaghetti tubing over ordinary wire. The rubber-covered line cord should be of No. 16 gauge wire and not the usual No. 18 or No. 20, as these wire sizes get

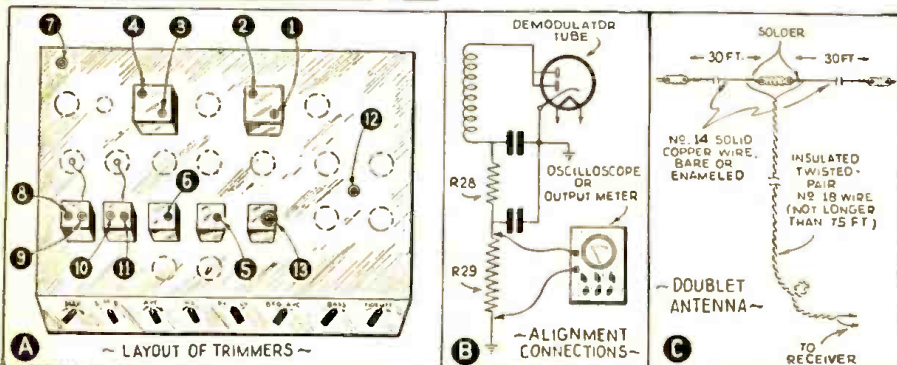

Fig. 16. In A are shown the trimmers to be adjusted in numerical order; in B, the method of connect-output meter or oscilloscope for alignment purposes; in C, the recommended antenna to be used.



Radio-Craft offers a copy of the "Official Radio Service Handbook," by J. T. Bernsley, to the set builder who submits a glossy photograph of the Radio-Craft Super Deluxe 30-Tube Set which in the opinion of the Editors appears to be the best job. The photograph must be at least 4 x 5 ins., or larger; it is desirable but not essential that the loudspeakers and rack construction be included in the view. This offer closes February 15, 1938. In view of (1) the step-by-step construction, (2) the independent serviceability of each chassis, (3) the simplicity of the fundamental design, and (4) the availability of Radio-Craft testing facilities in the event of trouble, we feel that many very fine jobs will have been turned out by our readers.

## THE POWER SUPPLY

### PART V

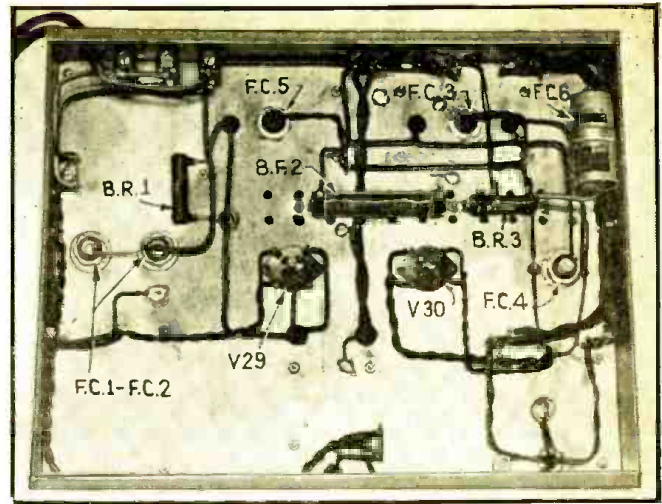

Fig. L. Under-chassis view of the power supply unit, Chassis No. 4.

warm when a current of 3 amperes flows through them.

Another point to look out for is the A.C. toggle switch. The ordinary size used for receivers won't do because the contacts are too small and would soon burn out. Use the 10-A. switch recommended in the parts list. A final point to remember is the aging of the 83 rectifier. These tubes contain mercury and should be aged for 15 minutes when brand new, before actually using them in the set. Simply apply 5 volts to the filament for 15 minutes. No voltage should be applied to the plates during this time.

A table of plate and screen-grid voltages for the entire set is given in this instalment, to aid the builders in trouble-shooting. All voltages are measured from socket contact to chassis with a 1,000 ohms/volt meter on the 500-volt range.

### ALIGNMENT PROCEDURE

Due to the fact that all of the R.F.

and I.F. transformers used in this set have been pre-tuned at the factory, the alignment procedure is greatly simplified because in the majority of cases it will be necessary only to touch a trimmer here and there to bring out the peak power.

However, in the event that a set might at some future time be tampered with or thrown completely out of alignment, the following procedure should be closely adhered to.

### PRELIMINARY STEPS

The Multi-wave Tuner that serves as the basic unit in this receiver has detailed alignment instructions packed in the carton, so we will not repeat them here. Plug all 4 chassis together, see that all tubes are plugged into their proper sockets and before turning the set on, connect either an oscilloscope or an output meter across the demodulator load resistor, from the junction of R28 and R29 to the chassis. See Fig. 16B.

We wish to point out that while the

set can be aligned very well with the old-style output meter and oscillator, it is only fair to state that a much finer job of alignment can be done by using a frequency-modulated signal generator and an oscilloscope, preferably of the 3-inch type. In either case you must use instruments. Do not attempt to align the set by ear or guess-work.

**FIRST STEP.** Set the signal generator at 175 kc. and let it run for 5 minutes before using it. Remove the grid lead from the cap of the 6L7 (V13), 2nd I.F. tube. Connect the leads from the signal generator to the cap of this tube and chassis. Before adjusting any trimmers, set the knobs on chassis No. 2 as follows: I.F. sensitivity, on *full*; Bandwidth switch, on *Sharp*; Noise Silencer on *Minimum*; A.V.C. Level on *Minimum*; DX-Local switch on *DX*; A.V.C.-B.F.O. switch should be set to the *A.V.C. on-B.F.O. off*, position. The Bass and Fidelity controls need not be set to any point in particular during

(Continued on page 494)

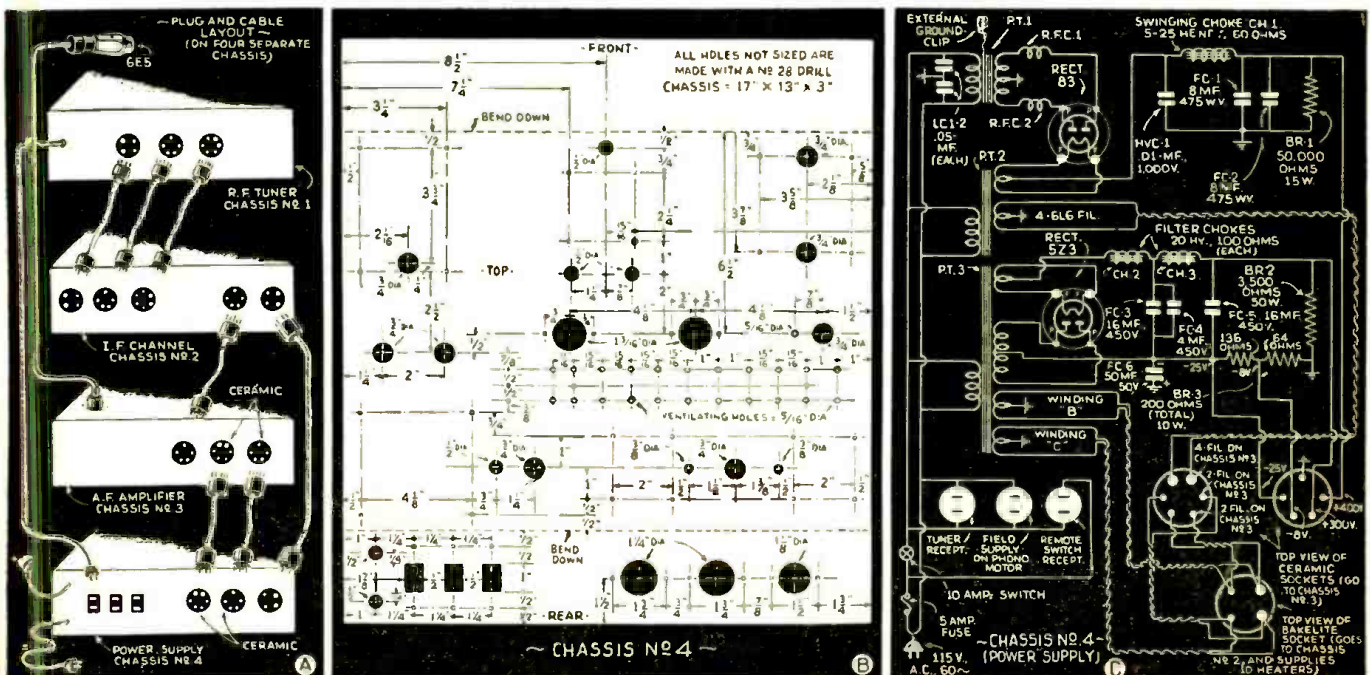
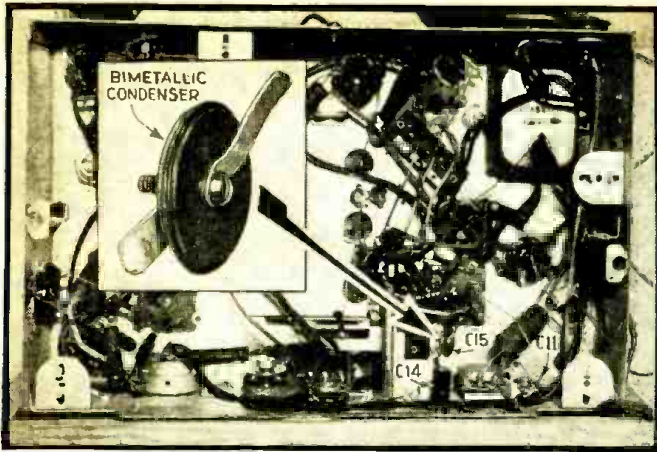

Fig. 15. A, sketch of all chassis showing the interconnecting cables; B, layout of the Power Supply Chassis; C, schematic circuit of the power supply.





The bimetallic condenser shown in the inset is here used in a commercial receiver. It compensates for frequency drift of the local oscillator in superhets. caused by the heat of the set.

# "BIMETALLIC CONDENSER" AIDS TUNING!

Automatically-tuned radio receivers at last have become practicable only through the application of precision tuning methods. A novel idea that maintains this precision during a set's warming-up period is described.

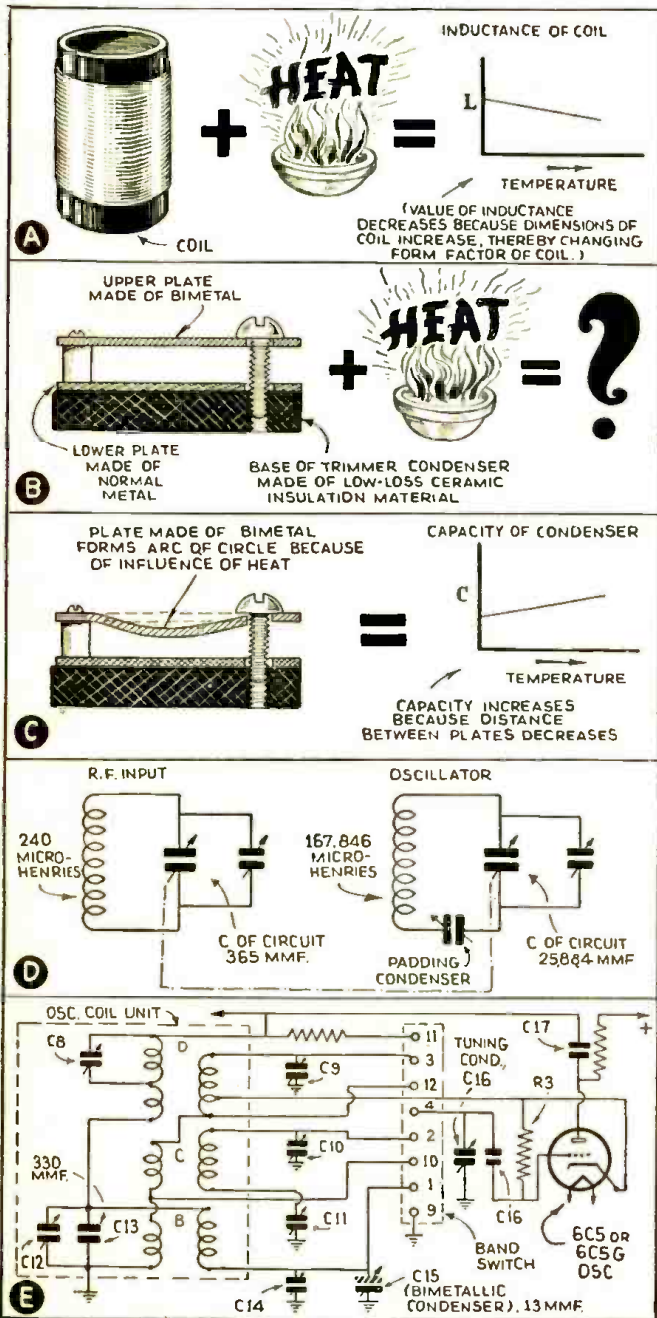

Fig. 1. Showing in A how the heat of a set affects the inductance of its tuning coils; and in B and C, how the bimetallic trimmer compensates for this detuning effect; in D, a typical, and in E, a commercial-set, circuit.

ONE OF THE interesting trends in present radio engineering is the attempt to gain frequency control of automatically-tuned receivers, not only by means of A.F.C. circuits, but also through the application of temperature-compensated tuning elements. Indeed, some modern pushbutton-controlled all-wave receivers do not use A.F.C. circuits at all, but are caused to operate by the application of temperature compensation only.

At first glance this information seems about as enlightening as would be a notice in the papers that "the famous British naturalist, W. W. Pyecraft, distinguishes between two kinds of germ plasm; the *heredity* plasm, which passes on from parents to progeny, and the *somato* or body plasm, of which the genes mold men, trees, anything that lives."

Let us forget all about this highbrow-sounding stuff and look at a simplified but practical explanation, as presented in Fig. 1A. We see a coil, the physical dimensions of which increase under the influence of heat. Despite the "well-known fact" that attempts have been made to use some of the lower-priced midget receivers for cooking and baking, one is hardly willing to believe that the average receiver of conservative design becomes so warm as to cause expansion of its coils exceeding split parts of an inch. One is therefore inclined to conclude from this calculation that the expansion of the coil as caused by heat is of negligible influence upon the proper functioning of the receiver.

## CAUSES OF RESONANCE DRIFT

Unfortunately, this conclusion is not correct. Every Service Man and amateur knows that 100% tracking on an average superhet. (one without automatic tuning) is one of those day-dreams which seldom comes true. The reason for this trouble is well known and simple: (1) improper design of the padding condenser; and (2) shift in the frequency of the local oscillator under the influence of heat, etc.

We know by calculation that a variable condenser with a maximum capacity of 25,884 mmf., and an inductance of exactly 167,846 mhy. are necessary for the oscillator circuit, in order to obtain an I.F. of 460 kc. in the broadcast band (540 to 1600 kc.). See Fig. 1D. Every small decrease in inductance in either the R.F. or oscillator coil will naturally cause frequency shift, with consequently mediocre reproduction of speech and music. If both coils are affected, it will cause detuning of the receiver during operation. This characteristic in a set which is supposed to be automatically tuned is, of course, intolerable.

This fault can be avoided when a trimmer condenser of a design similar to the one shown in Fig. 1B is used. The upper plate of such a condenser is, as indicated, made of *bimetal*, a special metallurgic product which bends under the influence of heat, forming the arc of a circle, as shown in Fig. 1C, and thus causing an increase in the capacity of the associated circuits. In other words, the *decrease of inductance* in the coil (caused by the expansion due to heat) is neutralized or balanced out by the *increase in capacity* of the small bimetallic trimmer condenser.

(Continued on page 496)



# NEW EQUIPMENT FOR ALL-WAVE RADIO

Experimenters in wavelength ranges both inside and outside the usual broadcast band will find on this page several new items of interest.

**Chairside Phono-Radio.** It is a hard fight but radio manufacturers are gradually getting away from technical appearances. To this end one manufacturer now offers an all-wave, 13.3 to 550 meter receiver with drop-leaves that cover-over both the phonograph and the radio control mechanisms. As shown in Fig. A only the decorative loudspeaker grille is seen normally (both lids down). (1558)

**3-Gang Midget Condenser.** Experimenters long have wanted a condenser gang for short-wave transmitters and receivers. A representative new unit of this type is shown in Fig. B. Gangs are now available with maximum capacities per section as follows: 20, 35, 100 and 140 mmf. (1559)

**All-Wave Armchair Radio Set with Automatic Tuning.** Even automatic tuning has successfully stormed the realm of armchair radio sets, as Fig. C illustrates; 10 favorite stations are available at the touch of a button; shelves for books and bric-a-brac add further utility to the instrument. Wavelength range is 16 to 550 meters. (Allied Radio Corp.)

**Load Coils and Wavetraps for the All-Wave Set.** In Fig. D is shown, at A, a loading coil which permits improved operation (reduction of whistles, etc.) on the broadcast band of an all-wave receiver without affecting short-wave sensitivity, an attenuation ratio of 10 to 1 may be obtained. The coil connects in shunt with the set's antenna-coil primary.

The wavetrapp shown at B is adjustable to interfering frequencies, at R.F. or I.F., that cause whistles, and other types of resonant interference. Attenuation ratios up to 500 to 1 may be

obtained without affecting the short-wave ranges. The coil connects in series with the primary or secondary circuit of the antenna coil. (1560)

**Radio-Tuning Motor.** Automatic tuning may be accomplished by means of the reversible motor shown in Fig. E. The use of balanced, differentially-connected shading coils (for automatic starting) results in inherently quiet operation. A contact of course is required in the radio set; and an A.F.C. circuit ordinarily must be utilized. (1561)

**Directional-Loop Antenna.** Although designed primarily for use with a particular type of radio receiver, the loop antenna shown in Fig. F is applicable to other types. This item is of special interest to owners of boats and planes; weather and other reports on wavelengths 550 meters may be tuned-in. The loop is shielded. It is rotated by means of the control unit shown; a 264 to 1 gear ratio affords accurate loop adjustment, and indicates by a needle on the scale. (1562)

**Radio and Power Outlet.** Service Men and owners of all-wave radio sets should study the merits of the outlet shown in Fig. G. It provides for wall-socket plug-in connection of the radio set to the power line and to a doublet antenna installation. It is impossible to accidentally interchange the two plugs. A dividing plate serves to isolate the two sections of the outlet. (1563)

(Continued on page 490)

Names and address of any manufacturer will be sent on receipt of self-addressed, stamped envelope. Kindly give (number) in above description of device.

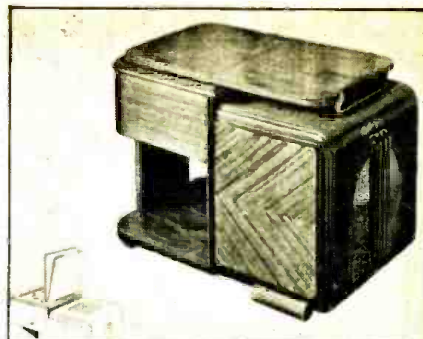

Fig. A. Chairside set. (Lower-left, leaves raised.)

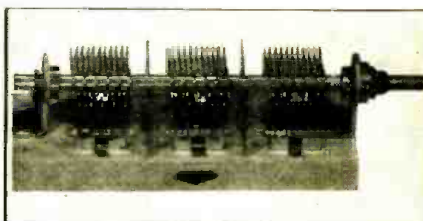

Fig. B. Ganged S.-W. condenser.



Fig. C. Pushbutton-tuning set.

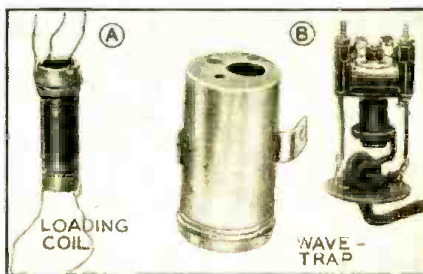

Fig. D. New coil units.



Fig. E. Motor



Fig. F. Directional loop.

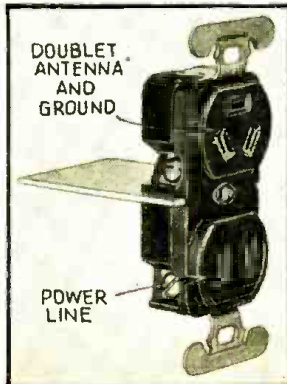

Fig. G. Newest wall outlet.



Fig. H. Variable condenser for small sets.



# HOW TO MAKE A SIMPLE 4-TUBE REGENERATIVE A.C.-D.C. SUPERHET.

A nifty little job for beginners! Regenerative 2nd-detector adds plenty of "wallop". As the picture diagram shows, a 5th or ballast tube is used. This set is very selective.

M. N. BEITMAN

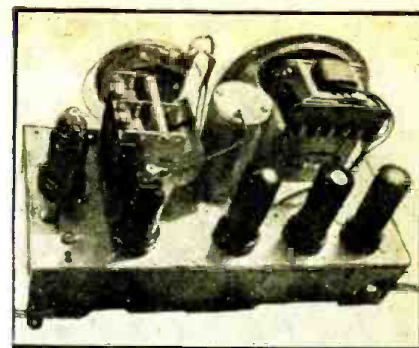

Fig. A. Rear view of the 4-tube Superhet. receiver.

**M**ANY DIFFERENT circuits have been designed around 4 tubes. Many of these use unusual arrangements of parts, others feature multi-purpose tubes. Let us see just what can be accomplished with single-function, modern tubes in a conventional circuit.

If the set is to be used on A.C. and D.C., and is also economical from the standpoint of first cost, the modern 0.3-ampere-type tubes must be used, connected in series. A rectifier is needed; and, to stick to late metal tubes, we are going to use a type 25Z6 connected as a half-wave rectifier. Working from the back end, we turn next to the power output tube. At the present time the newly-developed 25L6 beam power tube is about the best for series-filament sets. This tube takes care of a 25-volt drop in the filament circuit. The power output of the 25L6 is 2 watts and this is more than plenty for all requirements. By placing the choke in the negative-return of the power supply, we can use part of the voltage drop created there to bias the power tube. The plate supply for the 25L6 need not be exceptionally well filtered.

The ordinary 4-tube midget is a T.R.F. job and lacks selectivity. A single stage of I.F. with a carefully-adjusted, high-gain I.F. transformer runs circles around the gain obtained with a T.R.F. stage. By employing a pentagrid converter (type 6A8 tube) we combine the function of oscillator and mixer, and have the antenna coil to act as a preselector.

Next comes the I.F. transformer, coupling the 6A8 to the 6J7 detector. The gain is plenty, but to give the set the extra something, we included regeneration (feed-back). Notice in the circuit diagram (Fig. 1A) how the plate is coupled back to the second half of the secondary through the 5-50 mmf.

condenser. The 10,000-ohm resistor is in the plate circuit also to prevent oscillation. There are also numerous condensers for complete filtering.

The set can be easily wired and gives really good selectivity and tone quality. The fully-wired receiver, rear view, is shown in Fig. A. Note that the circuit ground is not connected in any manner to the outside ground. This will prevent possible short-circuits common to certain types of A.C.-D.C. sets.

The set may be aligned by listening to stations at about 600 and 1,200 kc., but a signal generator will give you better results. Connect the signal generator to primary of the I.F. transformer. Set the signal generator to produce 465 kc. and adjust I.F. transformer trimmers for maximum signal. Next connect generator to antenna circuit, set it to produce 600 and 1,200 kc. and adjust variable condenser trimmers for maximum signal. In most cases very little adjustment will be needed as the parts have been pre-adjusted at the factory. The regeneration control, while the adjustments are going on, is left loose, i.e., with the very minimum of capacity. After alignment is completed, it is adjusted for maximum signal.

If you want to obtain the most out of 4 tubes in straight-forward circuit, this is the radio set you should build.

## LIST OF PARTS

- \*One 2-gang condenser, 356 mmf., C1, C2;
- \*One antenna coil, L1;
- \*One oscillator coil, 465 kc., L1;
- \*One center-tapped I.F. transformer, 465 kc., I.F.T.;
- \*One trimmer condenser, 5-50 mmf.;

(Continued on page 499)

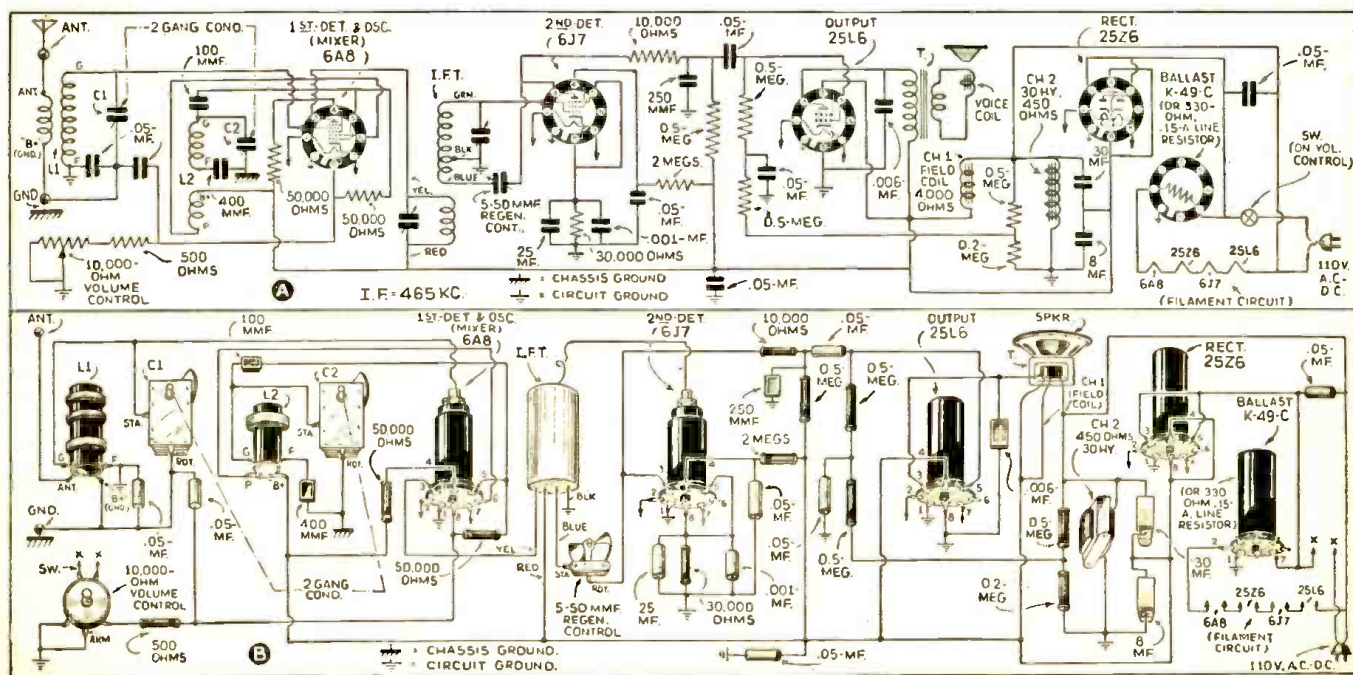

Fig. 1. In A is shown the schematic diagram of the 4-tube regenerative superheterodyne receiver; in B, pictorially, the wiring of the same set.



# 2-WAY POLICE RADIO OVER 1 ANTENNA!

Simultaneous transmit/receive operation over a single antenna is made possible, by means of a newly-developed filter unit (with one wire inside the other) and a well-designed receiver, at 7 meters.

C. W. PALMER

**A** NEW TYPE OF FILTER for use in simultaneous transmission and reception on ultra-highfrequencies for police-radio systems, has just been developed by engineers of the G.E. Co. This filter which can be used for both "station" and "mobile" police installations has several novel features that make it interesting to the radio technician. (This system was mentioned—in a general way—in the article, "Short-wave Radio Marches On!", in the December 1937 issue of *Radio-Craft*.—Editor)

This new filter permits **SIMULTANEOUS** "talking" and "listening" in the 30 to 42 megacycle (10 to 7 meters, respectively) police-radio band, from a single antenna. This provides the excellent reception afforded by the transmitting aerial without the expense of erecting costly headquarters receiving antennas in addition to the transmitting antenna. Also, in the case of the all-steel-top cars in mobile installations, the filter is the means for providing a very efficient receiving antenna by utilizing the transmitting aerial.

The filter has very high attenuation at the "elimination" or resonant frequency and very little or no attenuation to the band of adjacent frequencies. Therefore, neither the filter nor the receiver absorbs power from the transmitter. When used with well-designed receivers, this filter can be used to receive, without inter-action, signals differing in frequency by only 4 per cent from the transmitter frequency.

## PRINCIPLE OF NEW "HIGH-Q" FILTER UNIT

The principles under which this new high-frequency type of wave filter operate were described originally at the 1937

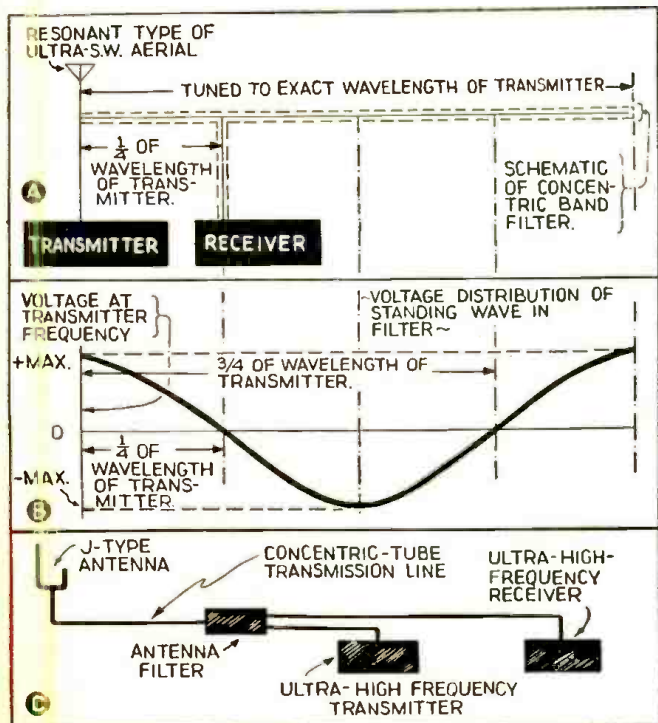

Fig. 1. A, how the "distributed-constant" tuned circuit is used as a band cut-off filter; B, voltage distribution of standing wave in the filter; C, block layout of the entire system.

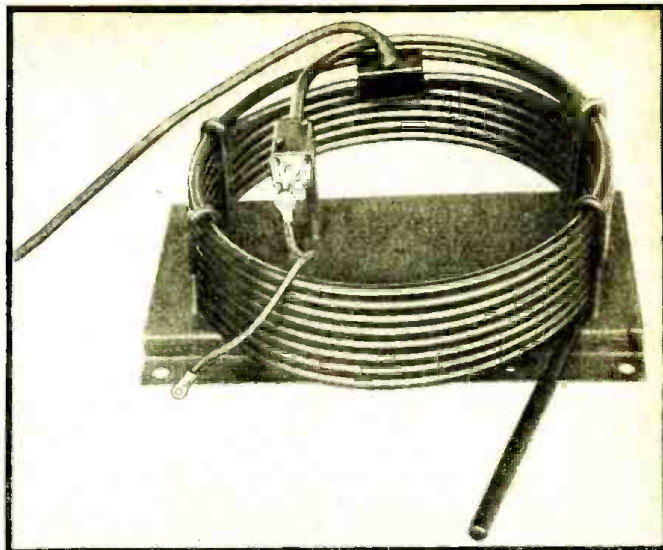

Fig. A. The concentric-line band-elimination filter used in connection with ultra-highfrequency police communication systems.

Convention of the I.R.E., in New York. It is a well-known fact that although common practice always demands "lumped" inductance and capacity in resonant (tuned) circuits, in the form of coils and condensers, similar resonant conditions can be obtained by spreading or distributing the inductance and capacity over a given circuit.

A common example of this effect is in the flat-top aerial which consists of a straight horizontal wire, yet has a definite inductance capacity and resonant frequency just as though it contained a coil and condenser.

On long wavelengths it is not feasible to use this "distributed" inductance and capacity for tuning because of the large physical proportions that the tuned circuit would assume. However, on ultra-highfrequencies it becomes a relatively easy matter to "fold up" the short length of tubing required for a distributed inductance and capacity tuned circuit. Moreover on ultra-highfrequencies such a tuned circuit displays a marked improvement over lumped inductance and capacity circuits, permitting Q factors of large magnitude to be obtained. (The Q, or efficiency figure, obtained with lumped coil and condenser circuits drops off rapidly with increase in frequency and is almost unity in the 2- to 3-meter band.)

An examination of the circuit in Fig. 1A will show just how this distributed-constant tuned circuit is used as a band cut-off filter tuned to the frequency of the transmitter, preventing signals of that particular frequency from passing to the receiver yet allowing signals of other frequencies to reach the receiving unit of the mobile or stationhouse police installation.

## CONCENTRIC-LINE FILTER

In any "concentric transmission line"—i.e., a line in which one of the two conductors is contained inside the tubular, second conductor— (which is another way of describing this distributed inductance and capacity tuned circuit), "standing waves" are built up over the length of the line at the resonant frequency, so that at certain points in the line, the voltage is zero. See Fig. 1B. It is at one of these zero points that the lead-in for the receiver is connected, which explains why no signals are picked up at the frequency of the transmitter (resonant frequency) yet signals of other frequencies pass through unobstructed.

The utilization of this effect permits the receiver to pick up signals of any other frequency, in the band to which it will tune, except the actual frequency of the transmitter which is connected to the same aerial as the receiver. At the actual frequency of the transmitter the receiver has a "deadspot" and no signals can be heard.

There is no doubt that this system of simultaneous 2-way conversation will find many other applications in ultra-short wave communication—its economies and flexibility making it a particularly suitable system for many different services.



# INTERNATIONAL RADIO REVIEW

RADIO-CRAFT receives hundreds of magazines from all parts of the world. Since the cost of subscribing to each of these would be prohibitive for most radio men, we have arranged with technical translators to prepare reviews for our readers.



Fig. A. English hi-fi speaker using small, fixed center cone to distribute the "highs".

**ENGLISH HI-FIDELITY DYNAMIC**  
**THIS UNUSUAL LOUDSPEAKER**, shown in Fig. A, was clipped from a recent ad in the *Wireless Retailer and Broadcaster* (London). Contrary to appearance, the center cone is not movable (See May '36 *Radio-Craft* for similar idea with moving cone), since it is a hollow cone of hard material that does not form a part of the moving cone material. This center cone serves as a distributor of high frequencies, and thus results in more even distribution of the high frequencies.

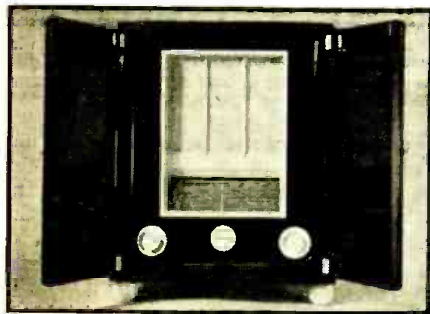

Fig. B. Novel German receiver housed in a beautifully designed modern plastic closing cabinet.

**MODERN PLASTIC PORTABLE**  
**THE ATTRACTIVE**, modern radio receiver shown in Fig. B was displayed at a recent Berlin Radio Exhibition. It is made by a German concern—Siemens & Halske—and due to its construction makes an ideal portable or home set. The cabinet is made of plastic material, a practice which is now becoming popular in this country, and includes closing front-doors. The net result is an all-wave chassis with a resplendent front and case which sets a new "high" in portable design.

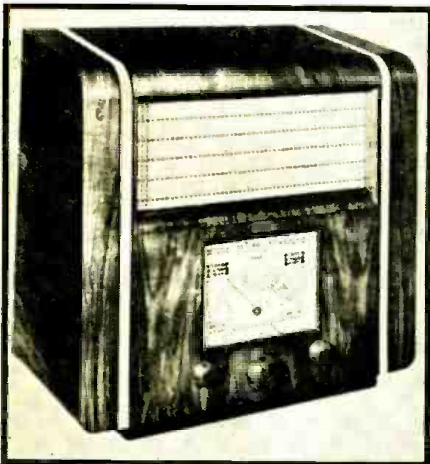

Fig. C. A useful innovation in this British set is the enlargement (by photographic projection) of that portion of the scale to which the dial points.

**NEW ENGLISH SET WITH CALIBRATION PROJECTOR**  
**AT THE RADIOLYMPIA** show in England the receiver shown in Fig. C attracted considerable, deserving attention. It is manufactured by Ferranti, and includes, as a feature, a "magnascopic" dial, which is shown in detail in Fig. D. This device operates to advantage on short-waves, since its construction permits projection and enlarging of the calibration figures on a screen on the front dial, thus permitting finer and more accurate tuning. An idea of the operation of the "magnascopic" dial may be obtained by referring to Fig. D, which shows the course of the light from a lamp (A), through a lens (B), through the dial

scale with its figures (C), then to an enlarging lens (D), to a mirror (E) from which it reflects back to a celluloid or other translucent-material screen. The location of this screen is on the larger tuning dial.

**DANISH 3-TUBE REFLEX SUPERHET**  
**REFLEX CIRCUITS** are still extensively used in Europe, although now practically unheard-of in the U.S.A. The Danish magazine *Populaer Radio*, in a recent issue, described the construction of an interesting 3-tube reflex superheterodyne receiver, the diagram of which is shown in Fig. 1. Here we find that the 3 tubes function as follows: tube V1—is termed an octode, the American equivalent of which probably is the 6A7 or 6A8, and which functions as a combination 1st-detector and oscillator; V2—is a duodiode-pentode (American equivalent—6B7 or 6B8) which functions as the 1st I.F. amplifier, 2nd-detector, A.V.C. and A.F. amplifier stage. The 3rd tube is a simple cathode-type half-wave rectifier (1V or 12Z3) which supplies "B" power from either 110 volts A.C. or D.C. The multiple functions obtained from V2 are obtained through reflexing, since the pentode section of the tube functions as both the I.F. and A.F. amplifier. The diode sections operate as 2nd-detector and A.V.C., each function being assigned to a diode-plate.

It should be noted by those who intend constructing this receiver that the values given in the diagram are those calculated to give best results with European tubes. Consequently, some slight changes or experimenting with values may be necessary with the American tubes before proper efficiency is obtained.

In the European version this receiver requires a switching system, A-B-C-D, to permit covering a longwave band above the top wavelength of 545 meters used in the U.S.

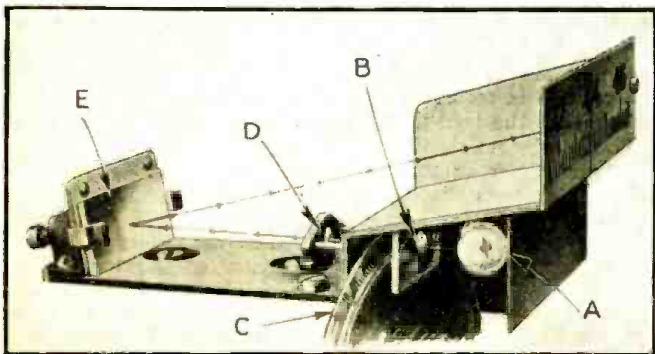

Fig. D. This is a close-up view of the dial-projection mechanism of the set pictured in Fig. C. The transparent calibrated dial passes through a light beam and is projected onto a mirror and then reflected back to a rectangular, translucent screen located on the dial at the front of the cabinet.

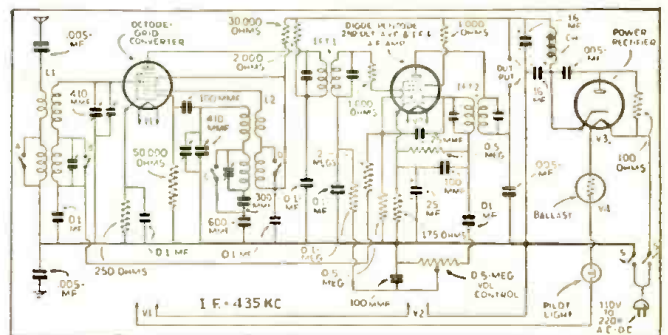
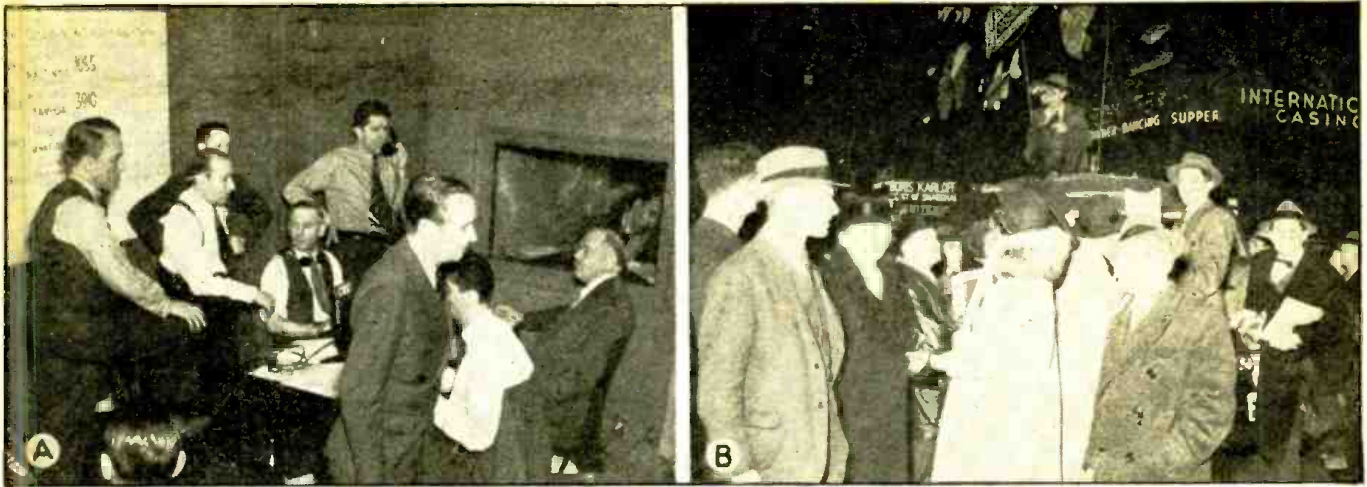

Fig. 1. Schematic circuit of a novel 3-tube superheterodyne receiver using the reflex principle. The circuit is that of a Danish receiver. The American Equivalents of the tubes shown above are probably: for V1 a 6A7 or 6A8; for V2 a 6B7 or 6B8; for V3 a 1V or 12Z3.





A, One of many typical busy scenes around the mike in a CBS-WABC studio. Note the "big board" on which the returns are tabulated. At B, NBC's Mobile Unit No. 1 in action at Times Square. All the radio networks had elaborate set-ups for reporting the election returns.

# HOW RADIO HANDLED THE ELECTIONS!

Back in 1920, presidential election returns (radioed from one station to a few thousand listeners) helped inaugurate broadcasting as we know it today. In '37, the reporting of election returns (via hundreds of stations, to millions of listeners-in), last month, reached new heights of network broadcasting studio and "NEMO" (remote pick-up) technique; for instance (in at least one set-up), remote pick-up points were contacted instantly by dialing!

**W**ITH NEW YORK CITY staging its most fiercely-contested mayoralty campaign in years, the major stations bent every effort toward providing complete coverage for radio listeners. Each had its own idea of the perfect set-up—spared no expense, no effort. All achieved good results.

What each station did in order to ensure the fullest information reaching its listeners with a minimum of delay makes a fascinating story of radio's inner workings; a story which would have been impossible 15 years ago.

The city station, WNYC, had set-ups at 5 remote points and in 2 studios, all of which were linked by interconnected private lines to the master control room, to provide instantaneous switchover facilities. At Police Headquarters, tabulations were read from the official bulletin board; at Times Square, members of the election crowds were interviewed, and bulletins from the *New York Times* on elections in various parts of the country were interpolated. Further data were secured from county watchers and reporters of the American Labor, Democratic and Republican parties, and statistical information came from the station's own Studio B, lulls being filled-in with music played in Studio C.

The set-up for WOR, key station of (Continued on page 505)



11:15 p.m. and most of the results have come in; after which they are tabulated and "shot" over the air from this CBS (WABC) studio. Drinking coffee helped keep the eyelids from drooping.

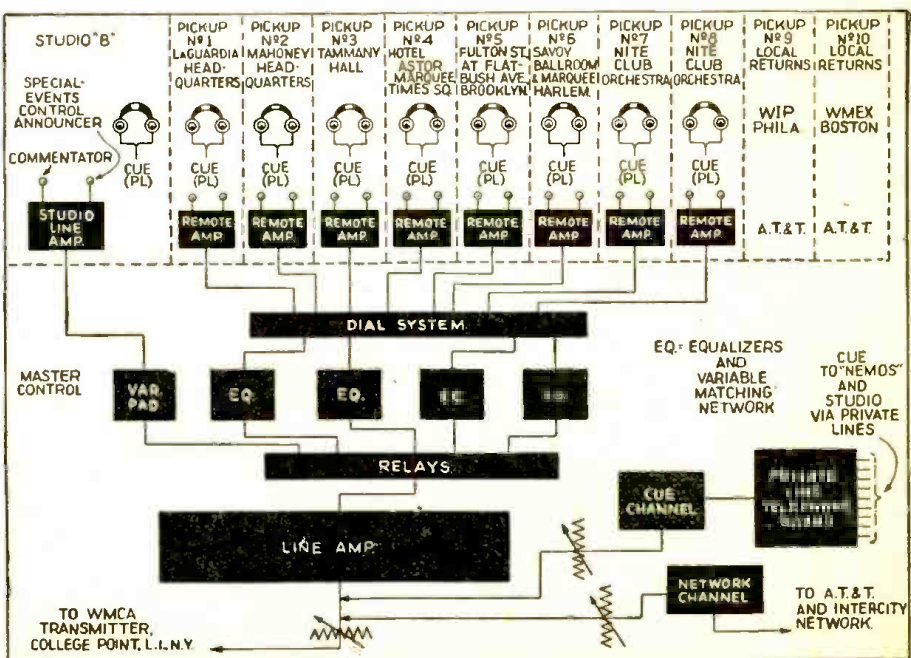

Block diagram of WMCA's (Intercity) elaborate "NEMO" (remote pick-up), and studio set-up for reporting election returns of N.Y.C., "Philly," and Boston. "Remotes" were cut-in just by dialing!



# SERVICING INSTRUMENTS FOR 1938

Reviewing the newest test instruments we observe that manufacturers have increased their figure of sensitivity. Also further progress has been effected towards securing speed and flexibility under practical working conditions. These improvements, in the final analysis, mean increased profits for the Service Man.



Super-flexible 2,000 ohms/volt unit. (1530)

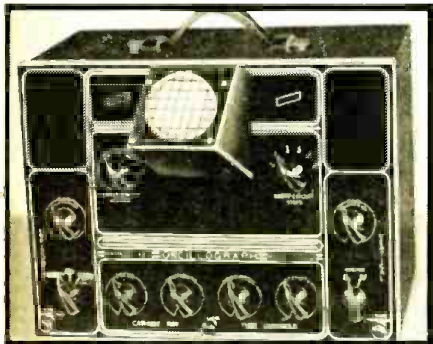

Note convenient angle of 'scope tube. (1531)



A 10,000 ohms/volt set analyzer. (1532)

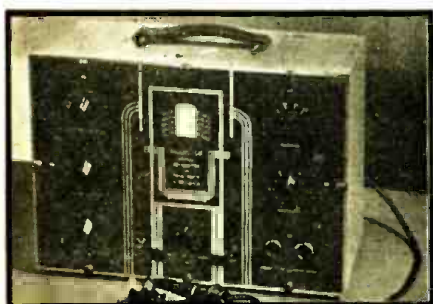

Signal generator has 8-ft. scale. (1533)

**U**P-TO-DATE Service Men will be exceptionally interested in the 6 new instruments illustrated on this page; and in noting the appreciable advance in test-equipment design over the period dating from the October 1937 special Test Equipment Number of Radio-Craft. (Incidentally, 7 servicing instruments were described in the October issue in the article "Latest Test Apparatus for the Service Man"; and, 6 service units were shown in the article "Test Equipment for the Service Man," in the July 1937 issue).

**"Super-Flexible" Tube and Set Tester.** Combining the model 321 tube and multitester (December 1937 *Radio-Craft*, item No. 1502) with the model 503 analyzer unit (November 1936, item No. 1199) makes available a "super-flexible" method of set testing. A different plug-in method of analyzing radio receivers, amplifiers, etc., at the socket is obtained without sacrificing the complete independence of either unit and without increasing size or bulkiness of (1) the basic tube unit or, (2) the multi-test unit. (1530)

(Radio City Products Co., Inc.)

**Alignment and Servicing Oscilloscope.** Add a good frequency-modulated service oscillator to this 3-in. oscilloscope and you have a complete set-up for visual alignment and service. Note that mounting the tube at an angle has put the screen at eye level. One sweep circuit is variable from 3 cycles to over 150,000 cycles; a 60-cycle sinusoidal sweep for simplification of visual alignment is also available. (1531)

**A 10,000 Ohms/Volt Set Analyzer.** This new model has a resistance of 10,000 ohms/volt D.C. Its current drain of 100 microamperes is low enough to assure extremely accurate measure-

ments of A.F.C., diode balancing circuits, grid currents of oscillator tubes and power tubes, bias of power detectors, and a wide range of unusual conditions that cannot be checked by conventional servicing instruments. A 12-position range selector switch automatically brings corresponding scales into view. Maximum ranges are: 1,000 V. D.C. (10,000 ohms/volt); 1,000 V. A.C. (1,000 ohms/volt); 20 megs.; and 100 microamperes. (1532)

**Signal Generator and Frequency Modulator with 8-Ft. Scale.** In order to eliminate *parallel* (wrong alignment of pointer and scale-indication) a hairline indicating shadow-tuner is utilized, to spot-light the individual range desired, on this newest modulated oscillator. The 340-degree dial has an actual scale length of over 8 ft. Excellent for use with an oscilloscope for visual alignment, since it emits: (1) unmodulated R.F., (2) 400-cycle amplitude modulated R.F., (3) 30-kc. band-wobble over I.F.-R.F. range, (4) fixed 400-cycle A.F., (5) variable 0 to 10,000-cycle A.F., (6) 130 kc. to 60 mc. R.F.-I.F. range. (1533)

(Supreme Instruments Corp.)

**25,000 Ohms/Volt Set Tester has Illuminated Meter.** A commendable step forward in test equipment has been inaugurated with the advent of this test unit which utilizes a *front-illuminated* indicating instrument; this feature reduces the possibilities for error by making the scale indications independent of room lighting. Instrument incorporates a condenser tester, free-point tester and decibel meter. Range (Continued on page 494)

Name and address of any manufacturer will be sent on receipt of self-addressed, stamped envelope. Kindly give (number) in above or following description of device.



25,000 ohms/volt set tester. (1534)

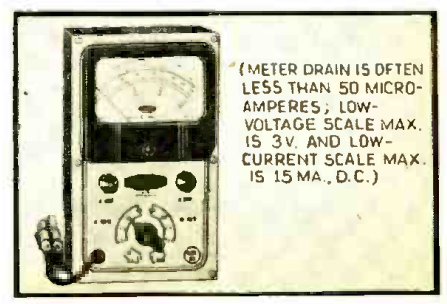

A 5,000 ohms/volt unit. (1535)

(METER DRAIN IS OFTEN LESS THAN 50 MICRO-AMPERES; LOW-VOLTAGE SCALE MAX. IS 3V. AND LOW-CURRENT SCALE MAX. IS 15 MA., D.C.)



# NEW CIRCUITS IN MODERN RADIO RECEIVERS

The details of the modern radio receiver circuits that make them "different" from previous designs are illustrated and described each month by a well-known technician.

F. L. SPRAYBERRY ..... No. 5

## (1) UNTUNED R.F. AND FIRST-DETECTOR IN MODERN SUPERHETERODYNE

RCA Model 813K. For tuning all of the short-wave bands, the only variable tuning used is that of the oscillator. Ganged to the main tuner is a small variable condenser which makes a total capacity change of the oscillator circuit of only slightly more than 9.2% in covering the lowest frequency short-wave band. It makes a smaller total capacity change for the other short-wave bands.

Throughout these very small bands where the best broadcasts are concentrated no R.F. or 1st-detector tuning is used as the loss, due to off-resonant tuning is negligible, and the difficulty introduced by tuning would not be justified. This may be better understood by an inspection of the very small bands that are tuned. Following is a list of the approximate percentage frequency change from minimum to maximum for each band:

Broadcast band	324%
49-meter band	4.5%
31-meter band	3%
25-meter band	2%
19-meter band	2%

The circuit is shown in Fig. 1A in the 19-meter position of the wave-band switch.

## (2) GREATLY SIMPLIFIED A.V.C. DELAY CIRCUIT

Philco Model 286A. A separate A.V.C. circuit using an ordinary 6J5G triode makes for considerable simplicity. The 2nd I.F. control-grid and suppressor-grid, and the R.F. and 1st I.F. suppressors are permanently biased at -3 volts. This is shown in Fig. 1B. The -3-volt bias is also applied to the A.V.C. control-grid through a 1-meg. resistor. As the signal voltage drop across the lower section of the plate coil of the 2nd I.F. amplifier exceeds a 3-volt peak, rectification starts in the A.V.C. tube making the control-grid become charged negative by the amount of the average carrier peak. This A.V.C. voltage controls the R.F. and 1st I.F. tubes by the conventional control-grid action.

With this A.V.C. system the A.F.C. circuit need not carry the A.V.C. potential and the detector circuit is separated for its best performance.

Any system or circuit which must perform a number of functions is improved by isolation from other circuits as far as possible. This circuit shows just another step in this direction.

## (3) NON-DEGENERATIVE BIAS FOR FIRST-AUDIO

Stewart-Warner Models 1911 to 1919. Since a fixed bias is almost always desirable for amplifiers both from the viewpoint of output and fidelity these receivers make use of a bias cell in series with the volume control as in Fig. 1C.

This direct, series grid connection of the bias cell marks a new application of it. It offers very little reactance or resistance to the signal supplied through it and is placed for the minimum possible signal current flow. Its use permits grounding directly the cathode and suppressor-grid of the 1st-stage audio amplifier 6S7G.

(Continued on page 498)

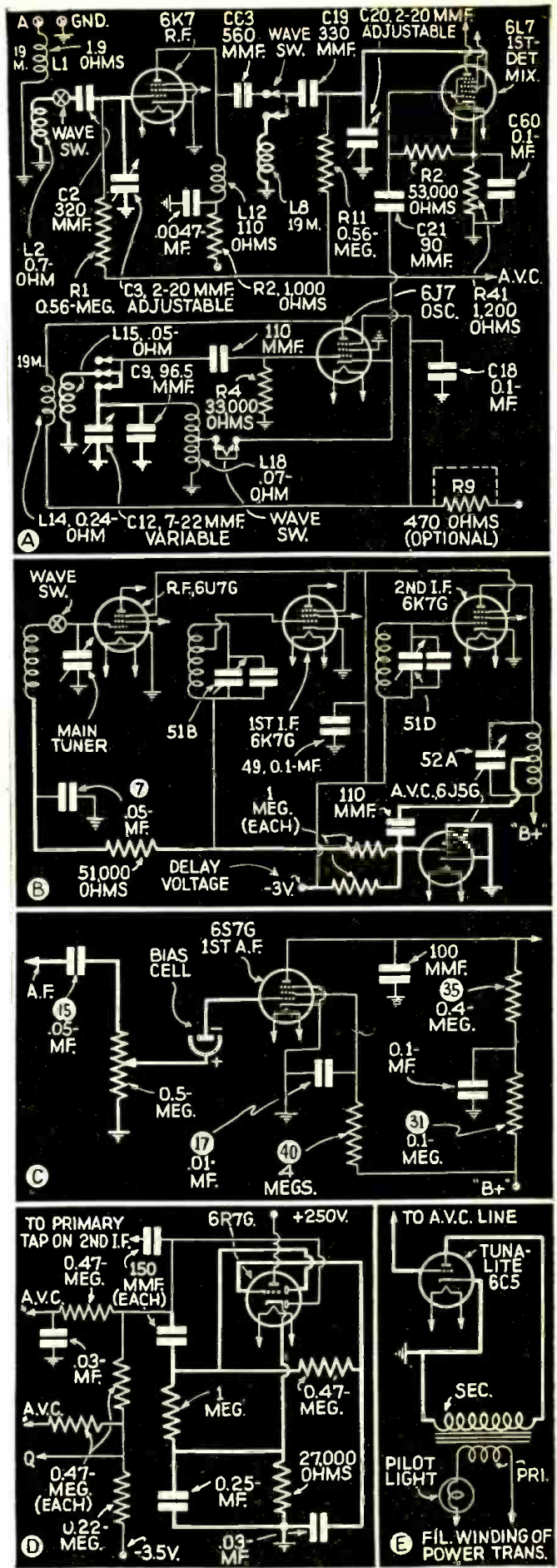

Fig. 1. Heavy lines in the circuits accent the points discussed in the text.



# THE LATEST RADIO EQUIPMENT

Technicians use this department to keep posted on the newer and better ways of doing things in Radio, Electronics, and Public Address.



Constant-impedance pot. (1537)

## CONSTANT-IMPEDANCE HEADPHONE CONTROL (1537)

(Centralab)

A WELL-KNOWN volume control unit designed for mounting on the headphone cord has been modernized. It now utilizes a constant-impedance "L"-pad attenuator circuit that eliminates loading mismatch. A worthwhile improvement in tone quality is thus obtained. (Circuit on continuation page.)

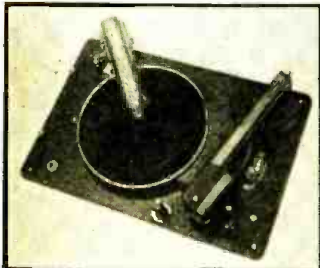

Servicing-type turntable. (1538)

## SERVICING-TYPE PHONO TURNTABLE (1538)

(RCA Manufacturing Co., Inc.)

TWO HIGH-QUALITY automatic record-changing mechanisms and a crystal pickup (impedance 40 ohms) and arm at prices which open up a highly profitable phonograph replacement and modernization market for service engineers have just been made available. The deluxe unit is illustrated. Needle is top-load and automatically adjusts to proper playing position; pressure is adjustable. "Plays" eight 10-in. or seven 12-in. records automatically.

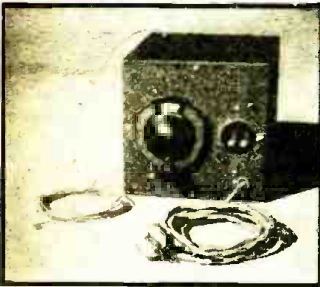

Electronic robot. (1539)

## CAPACITY-OPERATED APPROACH ALARM (1539)

A CAPACITY-OPERATED relay that closes a circuit whenever anyone approaches the "antenna"—which may be a wire, metal plate, screen, or other metal object—is available, which affords a novel attraction. This A.C.-D.C. device may be used for actuating advertising displays, announcing callers, protecting valuables, and generally controlling electrically-operated devices (up to 800 W. rating) without actual contact. Unit is available with time delay, limited time delay, and coded selection.



New "C"-bias transformer. (1540)

## BIAS-VOLTAGE TRANSFORMERS (1540)

A NEW LINE of transformers designed especially to furnish 90 to 500 V. D.C. for "C"-bias in radio transmitters has been announced; a rectifier filament winding is included. The unit illustrated covers only a portion of this range.

## MARINE LOUDSPEAKER IS WATERPROOF (1541)

THE MARINE-TYPE P.M. dynamic, monel-metal loudspeaker here shown is designed to operate under adverse weather conditions such as in ocean-going ship service. Immersing in salt water does not damage the instrument! Bell measures 14½ ins.; by a "folding back" design an air column length of 30 ins. is obtained; frequency response: 200 to 5,000 cycles.



Marine-type horn. (1541)

## HIGH-POWER P.M. DYNAMIC UNIT (1542)

HERE IS A dynamic horn unit, with permanent-magnet field, capable of continuous operation at 20 W.; sensitivity is sufficient to produce high output at low-input levels. Diaphragm, of duralumin, undergoes an electrochemical process to prevent corrosion; and is conveniently replaceable.

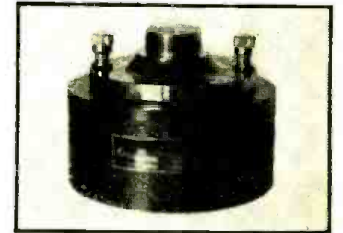

New P.M. dynamic unit. (1542)

## FLASHLIGHT SCREWDRIVER (1543)

ILLUMINATED screwdrivers have been described in past issues of *Radio-Craft* but the newest type is so small it clips into your pocket. Tool is furnished with standard battery and bulb. Tip of tempered steel is machine cross-ground to size; and magnetized. Recommended to radio, refrigerator, automotive and oil-burner Service Men. Handle is insulated. The small size of the tool is illustrated by the pencil alongside it; in fact, it's small enough to meet many alignment requirements.

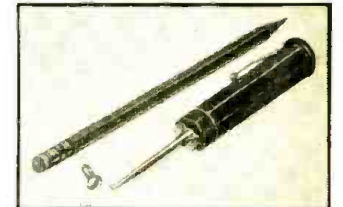

Illuminated screwdriver. (1543)

## 60-W. AMPLIFIER FEATURES VISUAL MONITORING (1544)

BOTH overload and output-level indication are obtained on indicator points in the new sound-system amplifier here illustrated. The entire rated output of 60 W. may be used in outdoor work; where music reproduction is paramount as in dance-band use operation at a lower power level affords tremendous reserve power to handle peaks without distortion. The frequency range at ± 1 db. is 40 to 12,000 cycles (not considering speaker distribution network). Microphone gain, 135 db.; phono gain, 61 db. Dimensions, 10¾ x 9¾ x 17 ins. long; weight, 51 lbs. Tube complement: 4-6F5's, 1-6R7, 1-6F6, 2-6E5's, 2-6L6's, 1-5Z3. 1.83.



60-W. amplifier. (1544)

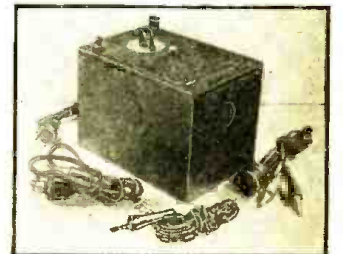

Line-noise analyzer. (1545)

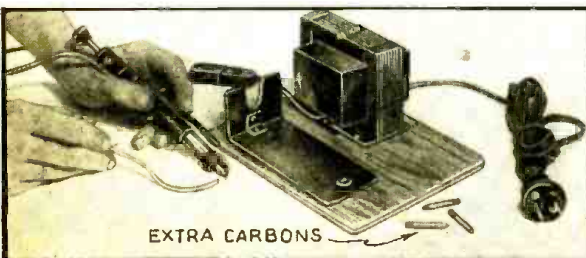

New patented-feature "iron" solves problems. (1546)

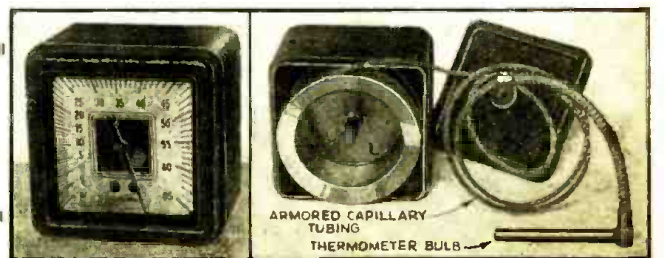

An aid to radio men servicing refrigerators. (1547)





"Pluggin" electrolytic. (1548)



2-V. storage cell. (1549)



Tiniest electrolytic. (1550)

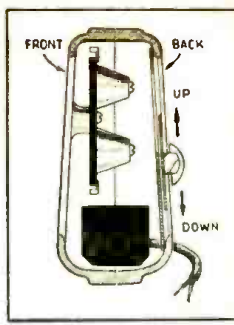

The Acoustic Compensator . . . in a velocity mike. (1551)



### \*"PLUGGIN" ELECTROLYTICS (1548)

**A** RADIO SET manufacturer has just brought out a radio set incorporating a type of electrolytic condenser equipped with a 4-prong ("Pluggin"—trade mark) base. This feature is great for servicing convenience.

Incidentally this condenser design enables experimenters and builders of original equipment to design and incorporate in their chassis a construction that requires no servicing of the condenser installation for the life of the equipment.

### RADIO-TYPE 2-VOLT CELL (1549)

**C**APACITY ratings of 160 and 100 ampere hours are available in a new line of storage cells designed for radio use. They are rated according to R.M.A. standards. The radio-type terminals have non-interchangeable marked caps.

### ULTRA-COMPACT WET ELECTROLYTICS (1550)

(Solar Manufacturing Corp.)

**A** NEW LINE of exceptionally compact, non-freezing wet electrolytic condensers has been announced. Capacity range is 8 mf. at 500 V. peak to 30 mf. at 100 V. peak. This unit will operate perfectly at  $-20^{\circ}$  C. whereas most electrolytics become inoperative at slightly below freezing point or zero-degrees C. ( $32^{\circ}$  F.). A new formation process which produces a highly stabilized film on the anode surface makes it possible to shelve these condensers for a year or more without excessive leakage resulting. The new electrolyte of course has a low freezing point; foil etching and a novel adaptation of the cylindrical fluted type of anode have helped achieve compactness.

### VELOCITY MIKE HAS ACOUSTIC COMPENSATOR (1551)

(Amperite Company)

**S**INCE tone controls are not conveniently adaptable to all P.A. systems a new microphone has been introduced which incorporates an "acoustic compensator." By a slight motion of the finger a shutter on the back of the microphone may be moved up or down in order to adjust the pitch of the system to the particular room's speaker, etc. In effect an acoustic baffle is produced which absorbs some of the lower frequencies and thus reduces the tendency toward peak response.

### COAXIAL CABLE FOR HI-FI PUBLIC ADDRESS (1552)

**A** MANY-USE coaxial cable has been designed which overcomes the limitations of earlier types and meets many needs in Radio, Public Address and Electronics. The central conductor is insulated from the flexible outside tubular conductor by means of elongated beads, of a plastic known as *anhygrom* (almost as good as quartz), which are strung on the central conductor like beads on a string.

Use this new coaxial cable for: high-fidelity public address voice-transmission lines; antenna lead-ins; transmitting antennas, transmission lines and feeders; lines between photoelectric cells and amplifiers; measuring instruments where high-frequency losses or conductivity losses must be reduced to a minimum; galvanometers

and electrometers; aircraft antenna lead-ins; etc. In short, use it wherever freedom from disturbances or from pick-up, or where good shielding or low capacity are desired.

### AUTOMATIC PHONO-RADIO PORTABLE (1553)

**S**OMETHING NEW in radio is this combination automatic phonograph and radio reproducer which plays eight 10-in. or seven 12-in. records automatically with the lid open or closed. Operates on 110 V. A.C. (An A.C.-D.C. model is also available.) The receiver is a 2-band superhet. utilizing 7 metal tubes.

### DELAYED-ACTION FUSE WIRE (1554)

**A** MOMENTARY short-circuit or a surge often cause a fuse to "blow" unnecessarily. A fuse has recently been introduced however which does not open-circuit unless the short or surge is maintained. This obviates the need (and attendant danger of equipment burn-outs) for using too-heavy fuses. Ordinary metals do not have this "lag" property. The problem was solved, however, by using a non-oxidizing filament of high-melting-point (nickel) wire, and mounting on it some tiny explosive blobs of powdered magnesium held in a suitable binder. The melting point of the nickel is some  $1,500^{\circ}$  C., but the flash point of the magnesium is only  $650^{\circ}$  C., and on burning it instantly generates some  $3,000$  or  $4,000^{\circ}$  C.

Thus an overload of appreciable duration heats the blobs of magnesium to their flash point, and on burning they melt the nickel filament and clear the fuse. High overloads of short duration, however, do not create sufficient heat to raise the blobs of magnesium to firing point.

The result is that one of these new "magnickel" fuses of  $\frac{1}{2}$  amp. rating will resist the same surges as a 1 amp. conventional radio cartridge fuse, and yet will blow on a 75 per cent overload if the overload persists for one second. This should at last remove all risk of burned-out radio sets.

### PORTABLE SOUND SYSTEM (1555)

**H**ERE IS A 10-W. sound system utilizing two 10-in. P.M. dynamic reproducers and a crystal microphone that will meet all the ordinary needs, indoors or out, that can be covered by a portable P.A. system having this power rating. Note the versatility of the collapsible microphone stand.

The amplifier unit is shown about mid-way between the two loudspeakers. In this main photo the microphone stand is shown extended to full-height (for orchestra use, etc.); the action-view insert at upper-left shows it completely collapsed (for use as a hand-mike); insert at upper-center shows it partly extended (as banquet-mike).

### METAL LATHE FOR THE SMALL PARTS WORKER (1556)

**S**HOP SERVICE MEN will be interested in a new 16-speed metal working lathe only 12 ins. between working centers. It is thus convenient for the clever workman to make, at low cost, replacement parts that often cannot be

(Continued on page 507)



Improved coaxial cable. (1552)

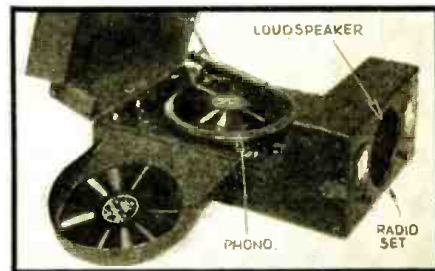

Automatic phono. radio. (1553)



New "delay" fuse. (1554)

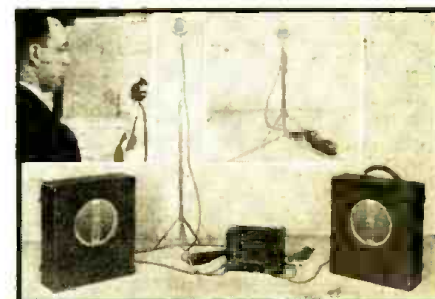

An efficient public-address system. (1555)

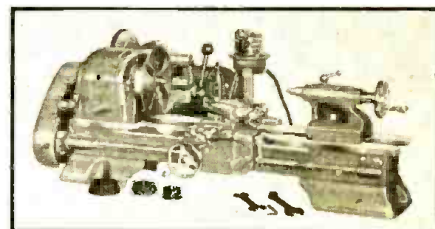

A lathe for small-work. (1556)



Suede-finish interphone. (1557)



# "LEARN-BY-EXPERIMENTING" BEGINNERS' PRACTICAL RADIO COURSE

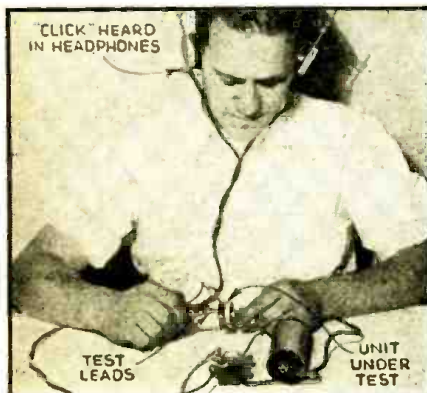

Fig. A. Simple continuity tests being made with the aid of headphones, test leads, and a drycell.

## EXPERIMENT NO. 5A

### TESTING RADIO PARTS

#### A—CONTINUITY TESTS

Learn radio while building useful radio units! A radio instructor conducts the Experiments.

CONDUCTED BY

SOL D. PRENSKY

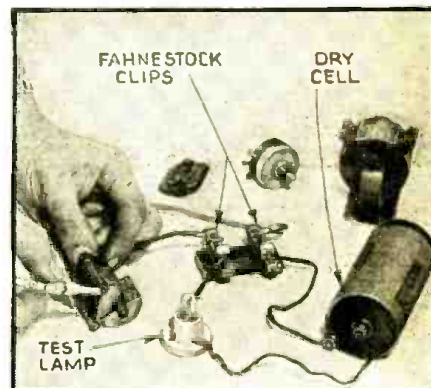

Fig. B. Simple "short" tests being made with the aid of a flashlight bulb, test leads, and a drycell.

**T**HIS EXPERIMENT on *Testing Radio Parts* is the 5th in the series of practical radio Experiments, and is divided into 2 Parts. This installment, numbered 5A, deals with testing the parts for defects like "open circuits" and "short-circuits," and this method of testing is usually known as *continuity testing*. The other Part of this Experiment (to be numbered 5B) will deal with *resistance testing*, in which method a meter is used to find the actual resistance of part being tested.

**Continuity Testing.** A very desirable method for testing any part in an assembled unit is to substitute a replacement part for the one being tested. This method, though very simple and definite, is not the most practical, as a full set of replacements is not usually available, and for any one of a number of other reasons, very often cannot be used. It is therefore necessary to be able to test each part separately, and it is with such methods that this Experiment is concerned. Beginners just starting in this Series, may find it desirable to refer to preceding Parts, in the event that any of the terms used here are not clear. All terms used here for the first time are *italicized*.

#### PRINCIPLES INVOLVED

The general idea in parts testing is to send a current through the part in question and observe how the part acts. This idea is used in the "old reliable" battery and phone test shown in Fig. A. When the 2 test leads are applied to a part, and a click is heard in the phone, it is then apparent that there are no breaks in the wire, that is, *no open-circuit*. Since this simple method determines whether the wiring is continuous and unbroken, it is called *continuity testing*. This method will test all parts which call for continuous circuits such as resistors, coils, transformers, etc. The 1½-volt cell indicated here, should give an audible click with parts having a *resistance up to about 1 megohm (1 million ohms)*. For higher resistances correspondingly higher voltages should be used.

Condensers may also be tested for an open-circuit, even though they do not have a continuous internal circuit. An audible click will result when the test leads are applied because of the charging current drawn by a good-size condenser. After the first contact or tap has been made to charge the condenser, *succeeding taps should not give a click*

*of the same loudness*; otherwise a short-circuit is indicated. With a 1½-volt cell an audible click can be obtained on the first contact of the test leads with *capacities as low as about 0.0005-mf. (or about 500 mmf.)*. Although doubling the voltage to 3 volts will allow the testing of condensers having only half the above capacity (0.00025-mf. or 250 mmf.), it is not practical to try to test any condensers much smaller than this, by this method. Also this method should not be used for electrolytic condensers, because, inherently, they have a comparatively high leakage.

#### TESTING FOR SHORT CIRCUITS

When testing parts having low resistance values, it will be practically impossible to distinguish between a part that is OK and one that is short-circuited, or, as it is usually termed by the practical radio man, "shorted". By the term *short-circuit* is meant a condition where the current can take an undesired path that has little, or practically no resistance. This term is one that is very widely used (and just as widely misused) in electrical work, and it is well to note that a "short"-circuit is so-called because of the low resistance of its path and not because of its short length. On testing of a low-resistance part that has this short-circuit condition, the click that is obtained in the phones will be just about as loud as that obtained with a good part (since the good part has a low resistance anyway) and so, in such cases, the "short" does not show up.

For this reason, a *method for testing shorts* is also given. This method uses the same drycell and a low-voltage bulb of the flashlight type. See Fig. B. (Continued on page 488)

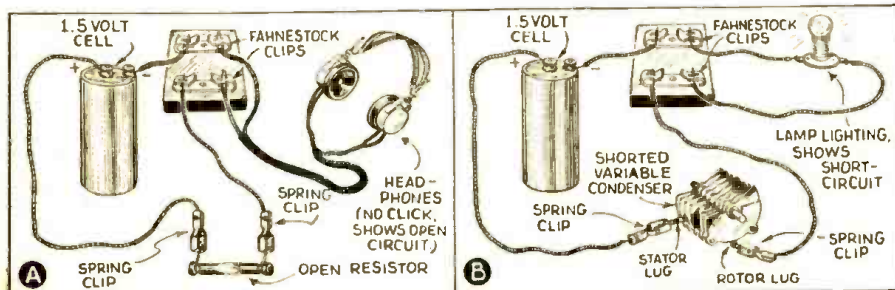

Fig. 1. Pictorial diagram showing the connections necessary to make simple (A) continuity, and (B) "short" tests. A click in the phones in the former and a lighting bulb in the latter are used as test indications. Read text for details.



Service Men may write, requesting answers to specific service questions. Address inquiries to Service Editor. For questions answered by mail, a service fee of 25c per question is made. Only questions of wide interest can be published. In view of the "rush" character of most service calls an effort is made to maintain 48-hour service on mail inquiries. Let us help you solve your service problems.

# SERVICING QUESTIONS & ANSWERS

Note: Test all tubes before writing to this department concerning a given servicing problem. All questions must contain complete information regarding symptoms, and tests to date, so that an adequate answer may be given.

## NOISE IN CAR-RADIO

(39) Robert E. Altomare

(Q.) I am forced to call for aid relative to correcting complaint of noise in an old Atwater Kent auto-radio model 756, installed in a Plymouth 1937 car.

The dynamotor was mounted under front seat, speaker under the right-side bulkhead, but the receiver proper, without the cabinet on the left side.

Condensers on generator, ignition and ammeter helped not at all. Chokes in "A" lead had no effect on noise reduction. Another receiver was temporarily installed in the car but with little improvement in noise reduction. An "over-the-top" antenna is used. Tests show this aerial to be responsible for little noise. Suppressors do not help.

What do you think is responsible for the tremendous amount of noise pick-up?

How could the circuit be changed to introduce inter-station noise suppression?

(A) The noise pick-up on the Atwater Kent model 756 automotive receiver in your case is probably due to 3 causes, any one or all of which will produce the symptoms outlined.

A well-shielded receiver for automotive service has long been a requisite for satisfactory opera-

tion. Unquestionably, there is a good deal of pick-up from surrounding cables, tubing, rods, etc. It is first essential to shield the receiver thoroughly, to prevent ignition noise pick-up. After that is accomplished make sure that the steering column, oil-gauge line and water temperature tubing are all well bonded and grounded at the engine side of bulkhead. Use a ground clamp to secure good contact to the steering column. Make grounding or bonding leads as short as possible to body and engine bolts.

The antenna mentioned as "over-the-top" type is a low-capacity antenna and, since it does not match the receiver in question, solution to your problem may be a pair of "running board" plates. These should be connected to the receiver through

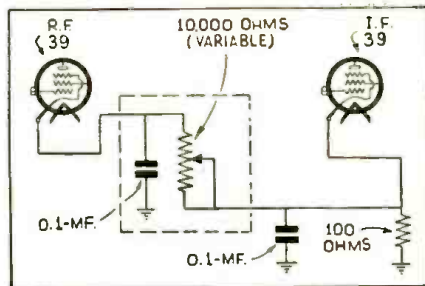

Fig. Q39. Adding a "noise control" to an A.K. 756 receiver.

low-capacity shielded cable, the shield of which is securely grounded at both ends. This type of antenna will provide the necessary "gain" due to better "matching".

For interstation noise suppression, connect a 10,000-ohm variable control into the cathode circuit of the R.F. 39 tube as in Fig. Q.39. As more resistance is introduced, the gain of this tube will become less and only signals of a strong character will be heard. (See Fig. Q.39A).

## WEAK VOLUME

(40) J. C. Trindle, Charles City, Iowa

(Q.) We are having trouble with a Coronado model 410B, a 4-tube, 2-volt battery set by Kingston. Weakness is main trouble. When ground wire is removed, volume increases slightly. The low frequencies are received very poorly. Tubes, batteries have all been replaced, as have been the wavetrap, antenna and oscillator coils. The alignment has been checked several times. The oscillator and antenna trimmers peak OK but the high-frequency trimmers are rather tight. Can you help us on this problem?

(A.) Unfortunately, no data for the Coronado model 410B is available. However, the symptoms described in your letter point toward trouble in the oscillator portion of the receiver, wherein oscillator frequency is below received frequency.

Suggest that alignment of oscillator be checked again, remembering that the correct adjustment for the oscillator shunt trimmer is at the (Continued on page 500)

# OPERATING NOTES ANALYSES of RADIO RECEIVER SYMPTOMS

Note that, effective with this issue, *Radio-Craft* will include special servicing data regarding late models, as released by manufacturers, inasmuch as these bulletins are not received by many Service Men. Service Men are requested to submit only illustrated, CHARACTERISTIC TROUBLES of radio sets; payment is made after publication.

Arvin 1937 Auto Radio Sets. Any vibrator noise which may occasionally increase to an undesirable level after a period of operation of an Arvin car-radio set may be corrected by the following procedure:

(1) Warm up the radio set by playing for 20 to 30 minutes. Tighten the 4 screws which hold the power transformer to the radio chassis. This will effectively eliminate most cases of vibrator interference.

(2) An additional remedy for R.F. interference is to cut the grounding braid connecting the tuning condenser to the radio chassis. The particular grounding braid is located close to the point of entry of the tuning flexible shaft. Do not cut any other grounds on the tuning condenser as this might introduce motor noise.

NOBLITT-SPARKS INDUSTRIES, INC.

Not Always the Volume Control's Fault. I was called in to change a volume control on a standard type of modern receiver, with dynamic speaker, and proceeded to do so, but the second volume control behaved in exactly the same manner, that is, it was silent to about half-way and then came on suddenly.

I took the chassis to my bench and tried another volume control, same result, and through checking of associated circuit disclosed nothing, so I went ahead with the centering of the voice coil, as I had noticed a very slight fuzz in the tone. When I tried to set again the volume control worked perfectly, and I can see no other

reason for its behaviour than the voice coil sticking at a certain point and requiring a certain strength of volume to loosen it.

As this might happen in any modern receiver I am sending it along in case it is worth printing.

A. S. MASON  
Kingston, Ont., Canada

Stewart-Warner Models 3041 to 3049. Some of the model 3041, 3042, or 3043 receiver circuits may oscillate or "growl" especially when tuned to weak stations or between stations. We have found that this oscillation can always be eliminated by connecting a ground to the receiver.

However, if a set is to be used without a ground, the circuit can be kept from oscillating by connecting a buffer condenser from one side of the power line to the chassis within the set. The condenser should have a capacity of 0.01-mf., and a voltage rating of 1,000 V. or more. If a shielded type is used, it can be soldered to the chassis under the loud speaker.

In connecting the buffer condenser, first solder one terminal to the chassis under the speaker. Turn on the set, then touch the other terminal to one wire of the line cord and note whether the hum increases or decreases. If the hum increases, touch the condenser terminal to the other wire in the line cord. Then connect the condenser to the line cord wire which causes a decrease in the hum. This will usually be the line cord wire which connects to the twisted wire from the on-off switch.

Later production receivers are being built with such a line buffer condenser to prevent any oscillation. Sets using the condenser can be identified by the letter "S" on the back of the chassis also on the outside of the carton near the serial number.

Condensers will be supplied without charge if you wish to install them in any of the sets you already have which are oscillating. No-charge orders will be honored only if serial numbers of the receivers are listed.

STEWART-WARNER CORP.

Stromberg-Carlson Labyrinth Models. Distortion and rattles in these receivers may be traced to the usual sources, such as:

(1) Foreign particles in speaker; (2) damaged or defective speaker cone; (3) loose voice coil; (4) voice coil off-center; (5) loose grille cloth.

In addition, check the following:  
(6) Foreign particles on top of labyrinth, or between labyrinth and cabinet; (7) loose screen over labyrinth exhaust in bottom of cabinet; (8) warped sound-spreading vanes striking against cone or leather.

If the screen is loose in the bottom of the cabinet, tack it down so it won't rattle. Its purpose is to keep mice, etc., from nesting in the radio cabinet.

In the case of warped sound-spreading vanes, it has been determined that this is caused by faulty handling or storage before the vanes were (Continued on page 503)







# 2,000 PARTS MAKE 1 MODERN RADIO SET!

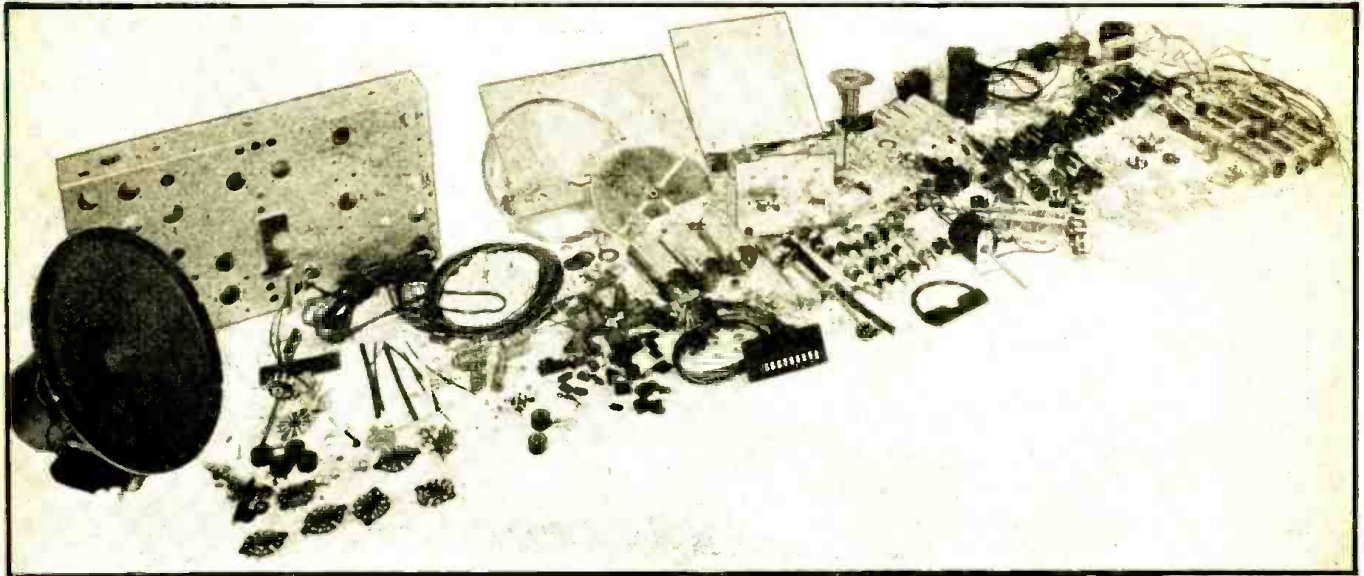

**A** MODERN, powerful radio set, capable of world-wide reception on all 6 wave-bands, is a delicate and complicated machine. Yet it must be put together without mistakes. Hundreds of minute parts must be fitted perfectly, and the final assembly must be a sturdy job.

The average automobile contains in the neighborhood of 2,000 separate parts, but its assembly is child's play as compared with the production of a radio set! An automobile can go through the factory and roll out on its own power in less than a day. But it is a far bigger job to put together a radio receiver that will operate under today's requirements

of long-distance reception.

Checking on the equipment used in a 20-tube receiver, engineers at a well-known factory got out their slide rules and did some figuring. The stock department laid out, as shown in the illustration, the equipment that goes into the 20-tube set. **THERE ARE EXACTLY 987 UNITS!**

But this is only part of the story. Each of the 20 tubes is counted as a unit, but each is in itself a delicate assembly of many parts. The power transformer, again considered but one of 987 units, is a complicated, finished product of  
(Continued on page 506)

## A NEW V.-T. VOLTMETER

Here is a vacuum-tube voltmeter which permits accurate measurement of "control" voltages. It incorporates a Reverse-Current Control and a Condenser-Diode Rectifier.

MACK STIER

**J**OHNNY Q. SERVICEMAN is a very much confused individual when it comes to servicing the latest radio receivers. As a matter of fact, the "Q" stands for the "question-mark" in his mind when he attempts, with average test equipment, to localize defects in any portion of an A.F.C., A.V.C., noise

suppression, volume expander or other similar stage of a modern set! It just isn't done so easily, and that goes for any 20,000-ohms-per-volt voltmeter, too.

### HOW TO MEASURE "CONTROL" VOLTAGES

The reason, of course, is that con-

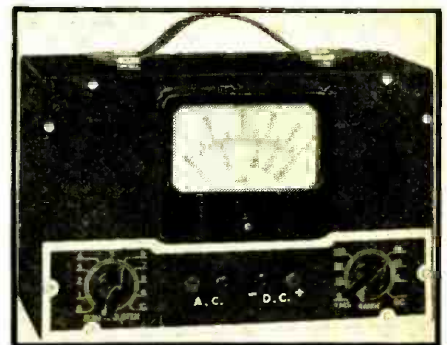

Fig. A. Appearance of the V.-T. voltmeter.

ventional test equipment isn't sensitive enough for rapid, accurate determination of the "controlling" voltages in the aforementioned circuits. By *control* voltages we mean the voltage which is responsible for the trigger-like action which takes place in each of the above, and which are the result of very small currents flowing through very high resistors.

For example, the load resistor in an A.V.C. circuit which is usually between 0.5- and 2 megs., and across which the A.V.C. voltage is developed. We know that the current which flows in this resistor is really the *rectified signal current*, and is of extremely small magnitude, even if amplified A.V.C. is employed. If we attempt to measure the voltage across this load resistor with an ordinary voltmeter, or even with

(Continued on page 499)

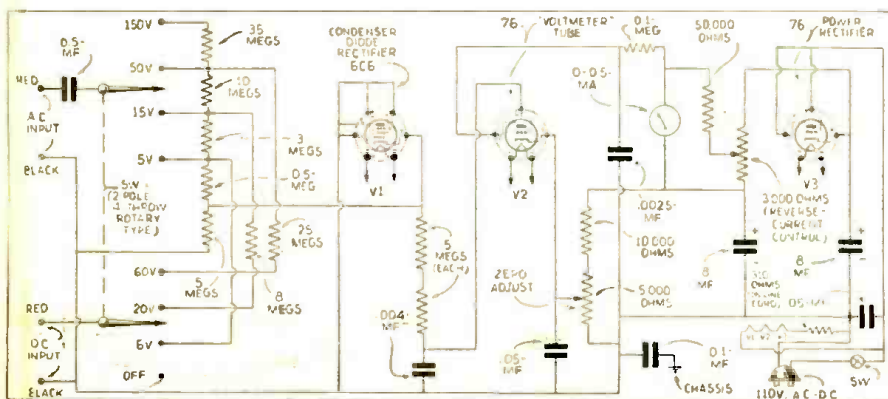

Fig. 1. Schematic diagram of the new A.C.-D.C. vacuum-tube voltmeter.



## PHILCO MODEL 38-116; CODE 125

15-tube A.C. superhet.; automatic tuning; bass compensation; automatic volume control; 5 bands (530 kc.-18.2 mc.); push-pull 6L6G output; variable I.F. selectivity; 15-W. output.

(See Data Sheet 222 for additional data)

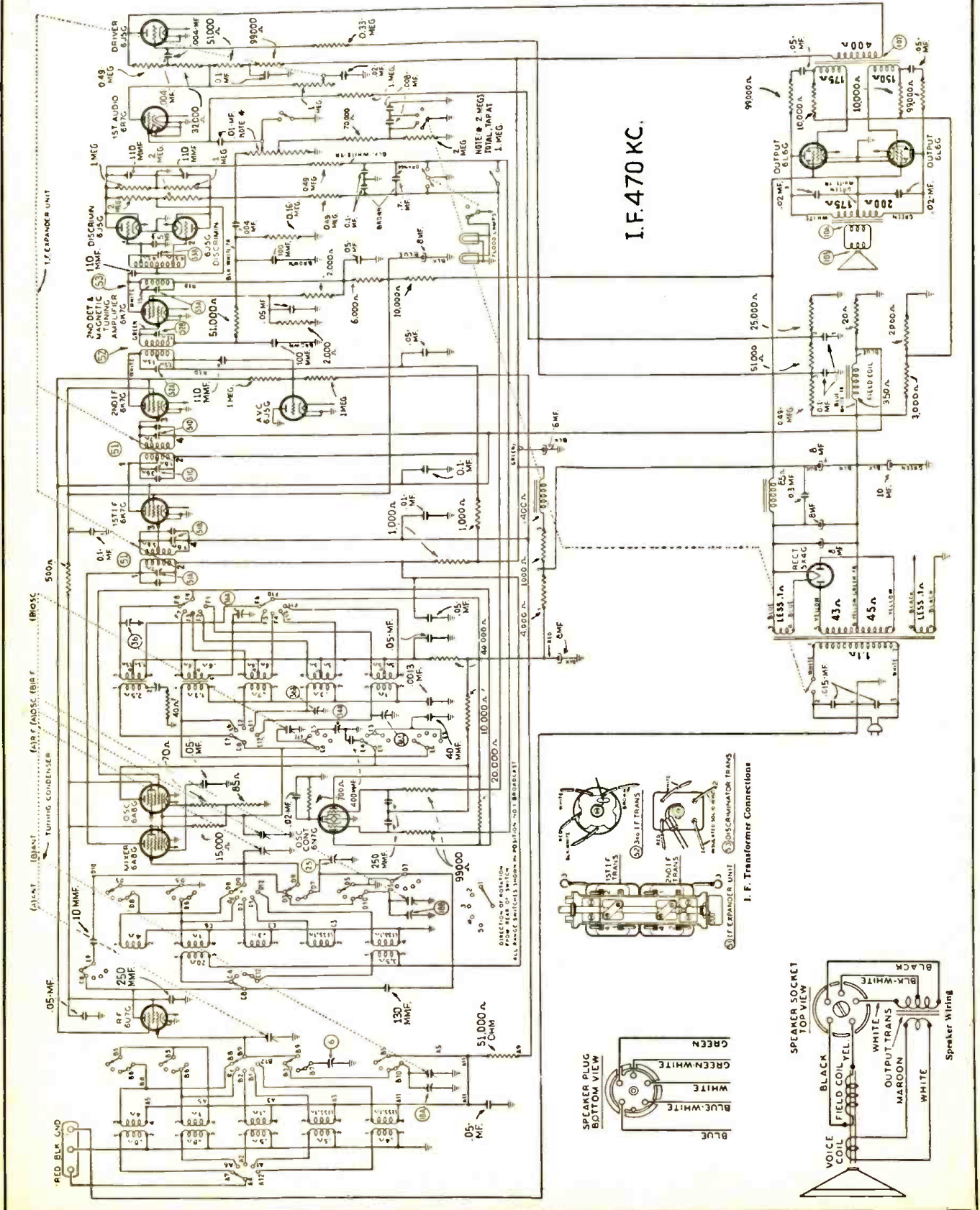

I.F. 470 KC.

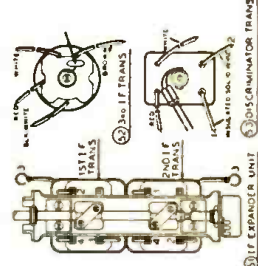

I. F. Transformer Connections

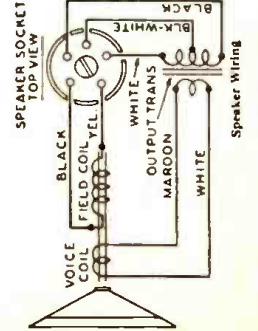
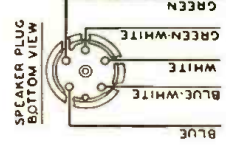



PHILCO MODEL 38-116; CODE 125

15-tube A.C. superhet.; automatic tuning; bass compensation; automatic volume control; 5 bands (530 kc.-18.2 mc.); push-pull 6L6G output; variable I.F. selectivity; 15-W. output.  
(See Data Sheet 221 for schematic circuit)

INTERMEDIATE-FREQUENCY CIRCUIT

1. Viewing each instrument from the front, set the receiver and Signal Generator controls as follows: (a) Selectivity-Fidelity control (clockwise). (b) Volume Control, at maximum (clockwise). (c) Magnetic Tuning Switch (off). (d) Bass Compensation Switch, first position from "off." (e) Range Switch, position 1 (broadcast). (f) Receiver Dial at 580 kc. (g) Signal generator indicator set at 470 kc.; and the "Attenuator" control for maximum output.

2. Connect the Signal Generator output cable through a 0.1-mf. condenser to the control-grid of the 2nd 6K7G I.F. tube. Then adjust the I.F. compensators as follows: (a) close compensator 52B by turning to the extreme clockwise position, then pad compensator 52A for maximum output. Now readjust compensator 52B for maximum output. (b) Connect the Signal Generator output lead through the 0.1-mf. condenser to the control-grid of the 6A8G mixer tube, and adjust the following compensators for maximum output: 51D, 51C, 51B, 51A. (c) Repad 52A (see Note A), check for 2 equal peaks. Treble-Selectivity control in expanded position (counter-clockwise).

RADIO-FREQUENCY CIRCUIT

1. Connect the Signal Generator output cable to the "Red" and "Blk" terminals on the aerial panel (rear of chassis). The ground connection of the cable should be connected to the "Blk" terminal. Set the controls as given under "Intermediate-Frequency Circuit" (a-b-c-d) and set the Range Switch, Signal Generator and Receiver Dials as given in the following procedure.

2. Set the controls and adjust the compensators for maximum output as follows:

Range Switch Position	Signal Generator	Compensators in Order
1	1,550 kc.	36, 18B, 18A
1	580 kc.	34
1	1,550 kc.	36, 18B, 18A
5	18 mc.	36C
5	18 mc.	25, 6, roll tuning condenser
4	11 mc.	36B
3	7 mc.	34A
2	4.5 mc.	36A
5	18 mc.	36C
5	18 mc.	25, 6, roll tuning condenser

MAGNETIC TUNING CIRCUIT ADJUSTMENT

(a) Set the Magnetic Tuning Switch in the "out" position (counter-clockwise). (b) Volume Control maximum (extreme clockwise). (c) Turn Treble-Selectivity control to the Selective position (extreme clockwise). (d) Now turn the signal generator indicator to the 1,000-ke. mark and adjust the "Attenuator" control for a weak signal. Then adjust the receiver dial for maximum output at this frequency.

NOTE: The receiver dial MUST be tuned very accurately to the 1,000-ke. signal in order to make the following adjustments correctly.

(e) After adjusting the receiver dial, turn the Magnetic Tuning Switch "on". (f) Now, turn compensator 53B slightly to the right or left (about 1/4-turn) and proceed with adjustment "g". (g) Adjust compensator 53A primary of the discriminator transformer for minimum output; then readjust compensator 53B secondary of discriminator transformer for maximum output.

The above adjustments are now checked for accuracy as follows:

**Frequency Test**  
With the 1,000-ke. signal tuned for maximum output turn the Magnetic Tuning Control back and forth; that is, from the "out" to "in" position. The reading of the output meter should not change in either position. If the output meter reading changes, magnetic tuning circuit adjustments should be repeated.

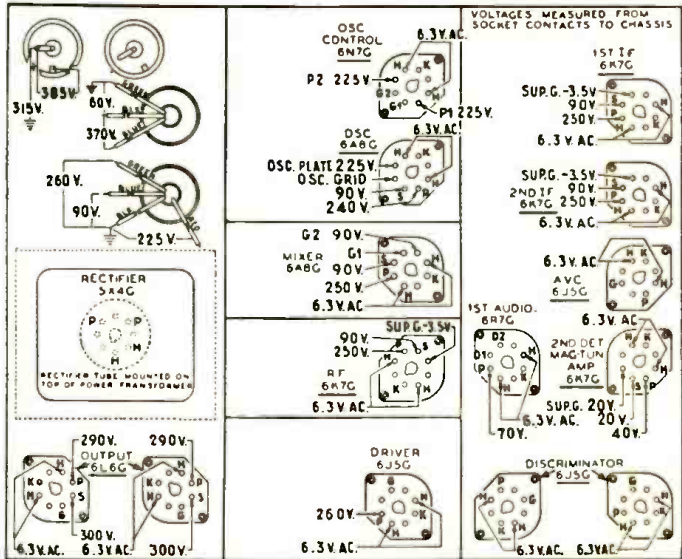

Fig. 1. Underside view of chassis showing socket voltages. The voltages indicated by the arrows were measured with a Philco 026 Circuit Tester, which contains a sensitive voltmeter. Line voltage 115 A.C.—Volume control minimum—Dial set at point where no signal is present—Range Switch in broadcast position.

A further check on the magnetic tuning adjustment is to very carefully tune in a broadcasting station and then turn the Magnetic Tuning Switch from the "out" to the "in" position. With the switch in either position, the tone of the station should not change. If a change of tone or hiss develops repeat the above Magnetic Tuning Adjustments.

Sensitivity Test

(1) To check the magnetic tuning circuit for sensitivity, turn the Magnetic Tuning Switch to the "off" position, and tune in the 1,000-ke. signal. Then adjust the "attenuator" control of the signal generator for a good audible signal—approximately 20 V. on the output meter.

(2) Now detune the signal (first above and then below the 1,000-ke. mark) to a point at which the signal is weakly heard. At each point turn the magnetic tuning control "on". When the control is turned "on" the signal should return to normal output strength. If the magnetic tuning circuit does not pull the signal into resonance, the primary compensator 53A should be carefully readjusted.

NOTE A—Slowly shift signal generator indicator between 460 and 480 kc. As the indicator is turned, 2 peaks will be noted on the output meter; one about 465 kc. and the other about 475 kc. These peaks should give the same deflection or reading on the output meter. If the peaks are unequal, compensator 52A must be slightly readjusted to the right or left (not more than 1/8 of a turn) until the peaks are equalized.

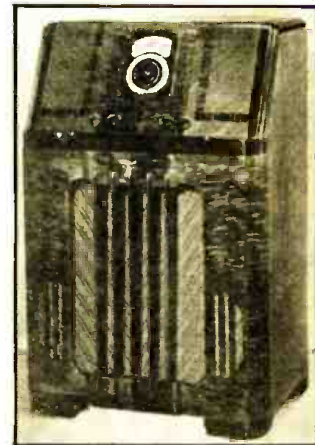

Fig. A. Philco model 38-116 console receiver.

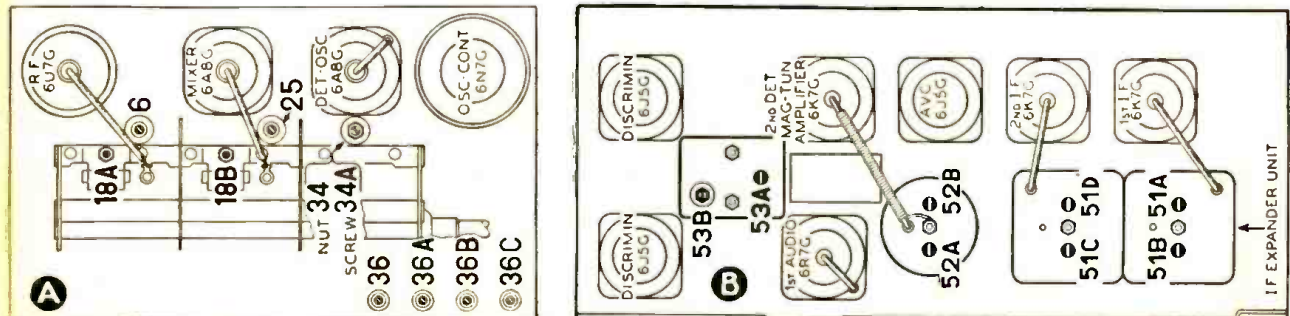

Fig. 2. Top view of (A) R.F. unit showing trimmer locations, and (B) I.F. unit showing trimmers.



## ARE YOU FOR OR AGAINST?

# THE QUESTION: Is Radio Servicing Merely a Stepping-Stone to Higher Positions In the Industry?

In the November, 1937, issue of *Radio-Craft* Mr. J. P. Kennedy, who is well known in the radio field, stated that "Radio servicing is not a goal but a stepping-stone to engineering or merchandising. As a permanent occupation it is probably the most difficult way you could choose to make a living." In a box appended to this article, the editors invited Service Men actively engaged in their

profession, to comment upon this statement. Did they agree or disagree with the viewpoints which Mr. Kennedy disclosed in his article? The 5 best letters received before October 15, 1937, were awarded a 2-year subscription to *Radio-Craft*. These as well as 3 additional letters, receiving Honorable Mention, are reprinted below. Additional comments from readers will be welcomed.

### HERE ARE THE ANSWERS:

#### AWARD

Dear Sirs:

I have read with deep interest an article by J. P. Kennedy, entitled "Is Radio Your Vocation?", in the November number of your magazine.

Mr. Kennedy, whom I recall as a contributor to *Radio-Craft* when he himself was engaged in service work, knows whereof he speaks, and I agree fully with his views.

Even so, there is nothing in Mr. Kennedy's article to deter the prospective Service Man from entering the field of his choice. Radio repair work alone is, in many cases, not sufficient to ensure a good income, but the intelligent, ambitious, and adequately-trained Service Man, possessed of sufficient working capital, will soon bridge the gap between the Service Man and the merchant, and will branch out into the radio and appliance sales, public address, and industrial electronics fields, or possibly into the parts distribution business. In Mr. Kennedy's own words "Thus you become a merchant selling not only your services but the products which you have learned to present to people in the most favorable light."

No normally ambitious man, starting out in any trade or profession, considers spending his life working at the bottom of the ladder, and in the radio field servicing is undoubtedly the bottom rung of that oft-mentioned ladder. No Service Man possessing a modicum of what it takes will remain such. It won't happen in a day, the transition may be gradual, but he will in time advance to a managerial or executive position in the merchandising field, or if his study has prepared him for it, to a responsible position in the engineering end of Radio.

Therein lies the enviable future, the gold in the Radio hills.

RALPH L. GREEN,  
Valparaiso, Ind.

#### AWARD

Dear Sir:

I certainly do not agree with Mr. Kennedy's statement that radio servicing is merely a stepping-stone to a better job or position and nothing more. Such a defeatist attitude toward the business of radio servicing is as pernicious as it is fallacious.

A Service Man who looks upon his work as merely a transitory stage with merchandising, engineering, or manufacturing as a final goal is certain not to put the enthusiasm and concentration into his business that it deserves and requires if it is to be given a fighting chance in the fierce competition of today.

Too much of this sort of thing is behind the present low estate of servicing. Almost invariably, radio servicing is combined with some other form of business activity. Perhaps it is selling radio sets; it may be a side line for a general electric shop; or it may be a spare time way of picking up a few extra dollars for a person who is regularly employed in some entirely disassociated business. In only a very few shops has radio servicing as a pure and unadulterated business been given a fair trial.

I firmly believe that if a man is willing to give the same amount of thought and effort to the building up of a radio servicing business that he would be required to put forth in any other business, he can build up an enterprise that will be just as large and just as remunerative as his business ability warrants. A man who intends to make servicing his life work will be constantly alert to new ways of improving his business. He will keep himself abreast of

#### WITTQUIZ and ORSMA DEPARTMENTS

In order to find room for the letters printed on this page, it was found necessary to omit the Wittquiz and ORSMA departments from this issue.

the most modern methods of servicing and advertising his business. He will be sure to take advantage of modern equipment in order to do faster, better servicing. Knowing that any permanent business must depend upon satisfied, repeating customers, he will see to it that his work is of the best quality and his relations with his customers are pleasant and business-like.

He will set aside a portion of his income for advertising and for new equipment. He will keep his eye on the growth of his business and will expand that business as rapidly as, but no more rapidly than, conditions warrant. He will augment his income from the actual repair of radios with other sources of income that are open to him as a Service Man: modernizing old receivers; installation of special antenna systems; installation of record-playing attachments; writing of technical articles for radio publications, etc.

He will do all these things, for he has cast his lot with radio servicing for better or worse, and he is determined that it shall be "for better." He is not stumbling along with his eye fixed upon a distant star; he is watching carefully every step he takes as he moves steadily forward in an interesting, rapidly growing, remunerative business.

JOHN T. FRYE,  
Logansport, Ind.

#### AWARD

Editor, *Radio-Craft*:

Have read and re-read the article in the November, 1937 issue of *Radio-Craft* several times, entitled "Is Radio Your Vocation?"

In a great many ways Mr. J. P. Kennedy is correct. In many more ways Mr. Kennedy either supposes a lot, is familiar only with the progressive radio Service Man, or is familiar only with the larger city Service Men. Radio is worth studying. There is a future to radio servicing. A man can make a good living in

(Continued on page 501)



# ALLIED OFFERS RADIO'S GREATEST VALUES!

*Just touch a button...  
THERE'S YOUR STATION!*

*Knight 6 TUBE SUPERHET only \$23.95*

*Everything IN RADIO AT LOWEST PRICES!*

**DOZENS OF KITS—OVER 12,000 PARTS!**  
Radio's largest selection of Kits—from beginner's One-Tube to 14 Tube Superhet, and over 12,000 exact duplicate and replacement parts for building or repairing any circuit—all shown in ALLIED'S great Catalog.

**P. A. SYSTEMS**  
KNIGHT Integrated Sound Systems for every P.A. need—8 to 60 Watts—Portable, Mobile and Permanent—and Inter-Com Systems—2 way, Selective and Super-Selective.

**TEST EQUIPMENT**  
Testers of every type—Analyzers, Tube Checkers, Set-Testers, Meters, Signal Generators—all nationally known brands. See them at lowest prices in ALLIED'S 1938 Catalog.

### KNIGHT PUSH-BUTTON TUNING MODELS AT STARTLING LOW PRICES!

KNIGHT Radios bring you Push-Button Tuning and every newest feature at prices that fit EVERYBODY'S purse. Here are radio's supreme values! The beautiful 6 Tube AC 2-Band Superhet shown above offers an R.C.A. and Hazeltine licensed circuit with Push-Button Tuning, new Slide-Rule Type Dial, Electric Eye, Tone Control, A.V.C., Electro, Dynamic Speaker, and 3 Watts power output—all for only \$23.95. In the 60 other KNIGHT models, you'll find values equally astonishing—made possible only by ALLIED'S volume and low distribution costs—prices that make the KNIGHT Radio's Greatest Value, offering biggest profits for you. 61 KNIGHTS to choose from—a set for every purpose—5 to 16 tubes, for AC, AC-DC, 6 Volt, 32 Volt, Battery, and Auto operation. See all 61 models in ALLIED'S Catalog. Send coupon now.

### DEALERS! • SERVICE MEN! • SOUND MEN! AMATEURS! • SET BUILDERS!

You all need ALLIED'S Catalog. Everything in radio in one great book, at lowest prices—164 pages of Sets, Parts, Kits, Sound Systems, Amateur Gear, Test Equipment, Books, Tools, etc.—every Radio requirement at your finger-tips for instant reference—easy to use and profitable to order from. For ALLIED'S low prices save you money. Send coupon today for ALLIED'S free 1938 Catalog—radio's complete supply guide!

**ALLIED RADIO CORP.**  
833 WEST JACKSON BLVD., CHICAGO  
Dept. 2-B8

Send your Free 1938 Catalog  
 Send Free Parts Lists for .....

Name .....

Address .....

City ..... State .....

**FREE Catalog**

Please Say That You Saw It in RADIO-CRAFT



**MARCH** *ahead* **OF TIME**

**WITH THESE NEW RIDER BOOKS**

These books were written to be used—and have been. Like RIDER'S MANUAL each is a proved book, selling year in and year out—edition after edition. These books have sold a total of 252,000 copies!

**VIBRATOR POWER SUPPLIES**

by Garstang and Rider

It becomes increasingly important that servicemen have the information on vibrator supply systems which is contained in this book. For vibrators are used in auto radio sets, 32-volt farm receivers, mobile P. A. systems, coin-operated music machines, etc. 280 pp. Profusely illustrated. \$3.00

**AUTOMATIC FREQUENCY CONTROL SYSTEMS**

With Automatic Frequency Control Circuits in most new higher-priced models, knowledge of "AFC" means money in your pocket! Learn the practical facts, from these easy-to-understand explanations. Get your copy today. Cosh in on profitable "AFC" work. Hard covers. 144 pp. \$1.00.

**THE CATHODE-RAY TUBE**

Written especially so you can understand the subject. With introduction of new, cheaper Cathode-Ray Tubes, this book is even more indispensable for its complete practical information on Oscillographs, etc. 336 pp. 450 illustrations. \$2.50

**SERVICING SUPERHETERODYNES**

Changes, changes, changes! That has been the history of the superheterodyne circuit. Make repairs quickly by analyzing the different parts of the circuit quickly. Rider shows you how in this revised edition which has 288 profusely illustrated pages. \$1.00

**"AN HOUR A DAY WITH RIDER" BOOKS. —60¢ each**

ON AUTOMATIC VOLUME CONTROL will speed up your AVC work. 96 pp. 65 illus.  
ON RESONANCE & ALIGNMENT. You need this! 96 pp. 48 illus.  
ON D-C VOLTAGE DISTRIBUTION IN RADIO RECEIVERS. How d-c voltages are led to tube elements, etc. 96 pp. 69 illus.  
ON ALTERNATING CURRENTS IN RADIO RECEIVERS—with drawings and diagrams.

JOHN F. RIDER, PUBLISHER  
1440 Broadway, New York City

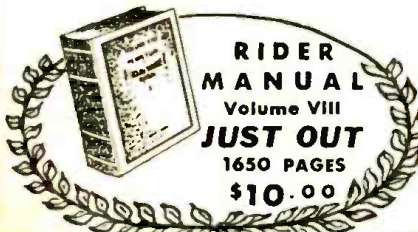

**YOU NEED ALL 8 Rider MANUALS**

**"LEARN-BY-EXPERIMENTING" BEGINNERS' PRACTICAL RADIO COURSE**

**TESTING RADIO PARTS**

(Continued from page 480)

Whenever a short is suspected, this method will indicate such a condition by the lighting of the bulb. The use of a low-drain bulb is specified here, not so much to preserve the life of the drycell (it is not properly a "battery" until 2 or more cells are used), as to make the bulb-test more flexible. Any resistance of less than about 30 ohms will cause this bulb to show some light, as it draws only 60 milliamperes at full brilliancy. Thus the bulb will light even when the short is not a perfect one, as is the most common case.

In using the bulb test on coils, it is necessary to keep in mind that coils having a few turns will, and should, cause the bulb to light brightly. This is as it should be, because the resistance of such coils (like short wave coils), when good, is extremely low. On the other hand, a coil for the broadcast band can be tested, if care is used, as it has a greater resistance. After some experience with observing the brightness of the bulb, it will be found to be a simple matter for the experimenter to recognize the difference in the brightness produced by a good broadcast coil winding and by a shorted one. Moreover, this difference in brightness will also prove useful in distinguishing between low-resistance rheostats, like the 6 and 20 ohm variety, that are usually hard to recognize on resistance tests using a meter, such as will be described in the next installment (Exp. 5B).

and observe if the bulb lights. If it does, it is an indication of a short-circuit (in this case, because the plates touch).

**(b) Testing An Unknown Part**

Test some part, the condition of which is unknown, to determine whether it is (a) open-circuited, (b) short-circuited or (c) good.

**Suggestion applying to classes or club groups:**

Let the teacher select 3 parts as unknowns, choosing, if possible, one having (a) an open-circuit, one having (b) a short-circuit, and one (c) good part, and labeling these simply as Unknowns 1, 2 and 3. The student then tests each part for open- and short-circuits and records the results by a check in the table below:

**CONCLUSION**

(1) An open-circuit may be detected by the absence of a click when the part is connected in series with a drycell and phones.

(2) A short-circuit may be detected by the lighting of a bulb when the part is placed in series with it and a battery.

**QUESTIONS**

1. A short-circuit is so called because the current path offered by it is: (short in length; low in resistance; or, not continuous).

2. In the continuity test with phones, does the primary or secondary of an audio transformer give the louder click?

3. In the above test, if no click is obtained, it is an indication that the circuit is: (definitely shorted; definitely continuous; or, definitely open).

4. In the above (continuity) test, a condenser is shorted if we obtain: (no click; a click on only the first contact and no clicks thereafter; or, repeated clicks).

5. In using the short-circuit test with a bulb, on a high-resistance unit (in this case anything between 100 and 1,000,000 ohms), if the bulb lights, it is an indication that the circuit is (definitely shorted; definitely open; or, definitely good).

\*Answers to these questions appear on page 494.

Teachers of radio classes and club groups are invited to write to the Editors concerning the use of reprints of parts of these Experiments in quantities for school use.

**LIST OF PARTS**

††One 1.5-volt drycell (the intermediate size is convenient);

††One Ph—pair of headphones, 2,000 ohms;

†Two fahnestock clips;

†One pair of test leads (a 2-color pair, 3 ft. long, with spade lugs and alligator spring clips is convenient);

One B—bulb, flashlight type, 2 volt, 60 ma.;

One miniature socket for above with screw terminals, porcelain;

†Also parts to be tested, such as audio transformer, fixed condenser (any capacity above 0.0005-mf.), and variable condenser; and any parts of unknown condition if available. (Suggestion for such unknowns for school group: open resistor, shorted volume control, good transformer.)

†Parts so marked were used in preceding Experiments.

†Most Radio mail order houses can supply this item if properly identified as to title of article, issue (month) of Radio-Craft and year.

**PART A—CONTINUITY TESTING**

**Procedure and Results**

(1) Open-Circuit Test with Phones—The pair of headphones and dry cell are connected as shown in Fig. 1A, using fahnestock clips as binding posts to facilitate connection to the phone tips. (Note: The polarity of the battery does not matter). A fairly long pair of test leads (about 2 to 3 ft. long) ending in spring clips will be found convenient. Tap the two free ends of the test-lead clips together to get a click in the phones.

**(a) High- and Low-Resistance Test**

Test the primary of an audio-frequency (or, as it is often called, just "audio") transformer. (Note: This primary winding is, in effect, equivalent to a resistance of the order of a thousand ohms.) Clip one test lead to the terminal of the primary, and tap the other test lead on the other primary terminal. Observe the loudness of the click, indicating a continuous circuit.

Test the secondary of an audio transformer. (Note: This secondary winding is, in effect, equivalent to a resistance of the order of ten thousand ohms.) Observe if the click for the secondary is weaker than it is for the primary.

**(b) Condenser Test**

Test a fixed condenser. (This may be a mica or paper condenser having a capacity of 0.0005-mf., or preferably, higher.) Note if any clicks are heard after the first few taps. If such evidence of a continuous circuit is found in this type of condenser, the part is to be rejected as unsatisfactory.

(2) Short-Circuit Test with Bulb—The bulb and drycell are connected as shown in Fig. 1B, and the test leads are attached as before. Touch the test leads together and observe the brightness of the bulb.

**(a) "Short" Test**

Test a variable condenser by rotating its shaft

**TABULATE YOUR RESULTS HERE**

Part	Open	Shorted	Good
Unknown 1			
Unknown 2			
Unknown 3			

Please Say That You Saw It in RADIO-CRAFT



## HOW TO STAGE A HOME BROADCAST

(Continued from page 466)

when they have finished, so that they get a chance to participate in the fun passively as well as actively.

### SOUND EFFECTS FOR THE AMATEUR PROGRAM

One thing that certainly shouldn't stump you is the sound effects and the more of these, the merrier. It is always amusing to actually see what crude apparatus is used to produce the realistic sounds.

Of course, you can have elaborate apparatus, too. Many good sounds are obtainable on phonograph records, and these are widely used by commercial stations. For example, there is a recording of locomotive effects—starting, running, and stopping. There are traffic effects, airplane effects, and crowd noises. One disc bearing the latter is to be run at 78 r.p.m., and if you run it at 33 r.p.m. instead, there are apt to be some red faces at a mixed party, for the words become intelligible at the slower speed.

Now refer to Fig. 2, which illustrates the particular group of 7 effects incorporated in the amateur-program script appearing at the end of this article; and also refer to the word description, immediately following, of these effects.

**WATER**—Water gives an excellent imitation of water. To imitate the sound of splashing water, simply splash water. If you wrap a bucket around the water, as illustrated, it will hold together better than if you just try to stand the water loose on the table, with nothing around it, for water is very difficult to pile up.

**AIRPLANE**—The sound of an airplane is simulated by holding a piece of cardboard against the whirling blade of an electric fan. For an approaching airplane, bring the effect closer to the mike; for a receding plane, take it away. The plane will sound as if it is going more slowly if the card is held near the ends of the blades; faster, if near the center. Look out for your fingers, because electric fans sometimes snap at you.

**FOOTSTEPS**—Footsteps sound more like footsteps than anything except footsteps. Have somebody hold the mike close to your feet as you, wearing shoes with leather heels, walk on a bare floor. If nobody will carry the mike, carry it yourself, as illustrated.

**BOMB**—To simulate an explosion, strike a leather cushion with a flat stick. The wider the stick, the bigger the "bomb." For the wreckage which follows the explosion, crush a thin wooden berry box, which is held close to the mike (see "CRASH" illustration).

**CLOCK STRIKE**—The chime of a striking clock can be imitated by hitting a fryingpan with the handle of a knife. Different tones are had by using different size pans (or even small pots) and by using knives with metal, bone or wooden handles. Experiment until you find the one which best suits your aesthetic sense.

**WHISTLE**—The deep tones of a boat whistle may be had by blowing across the top of the mouth of a thoroughly empty bottle. The larger the bottle and the wider its mouth, the deeper the tone.

**FIRE**—The crackling of flames comes out of the loudspeaker when the noise made by crinkling a crumpled sheet of cellophane goes into the microphone. The cellophane may be taken from a pack of cigarettes. When the fire gets bad and the roof of the burning building supposedly collapses—break up a berry box, as described under "BOMB".

Having mastered these effects, for our "amateur hour," let us see how some of the other and more pretentious sound effects are managed. (Radio-Craft readers may recall that some of them have been illustrated and described in past issues.—Editor)

### ADDITIONAL SOUND EFFECTS

**HORSES HOOF**s—Horses' hoofbeats are best done with 2 "plumber's friends" or halves of a coconut shell, one being held in each hand and "kloppety-klopped" on your chest or a table top in proper rhythm. But as coconut shells are not always available, so heavy teacups may be used with not-so-good results. Galloping is easy to imitate with the hands and lap. The left hand is held with the palm about three-quarters upward, approximately 8 inches above the lap. Now slap the palm with the fingers of the right hand which then continue onward to smack the right thigh as the left hand follows to slap the left thigh. The faster you do it, the faster the horse gallops. And the harder you do it, the closer he is to the microphone—and the more it hurts. The microphone, of course, should be placed near the hands, and the volume control stepped up as much as is required.

**RUNNING FEET**—The easiest way to simulate the sound of running feet is to place the microphone on a cushion on the floor and run past it. The reason for the cushion is to avoid shaking the mike; it makes a horrible sound if it's shaken while connected, and the little carbon grains inside it may be damaged when a carbon mike is used. If they are hurt, the microphone becomes what technicians term "on the bum". Always disconnect the "mike" battery when the microphone is moved. Then you can shake the mike as much as your heart desires.

**RAILROAD TRAINS**—Railroad trains are easy to fake as far as the sound is concerned. Two pieces of sandpaper rubbed together with the correct tempo make the chuff-chuff of the steam. The speed with which they are rubbed can make the train stop or start. To make it approach or leave the scene, walk toward or away from the microphone. But better do it in your stocking feet to avoid unwanted noise. The boat whistle can be counterfeited on a toy ocarina, or by whistling into your cupped hands. If you don't know how to whistle that way, any boy in the 5th Grade of grammar school can teach you.

If you still can't get it (NOTE: We couldn't.—Ed.) you can blow into the neck of an empty soda-pop or beer bottle, depending upon what sort of party it is. The sound will be reasonably accurate. For deeper tones, use larger bottles; for higher tones, smaller ones. Don't try partly filling the bottle with water to change the pitch.

(Continued on following page)

# RAYTHEON

MEETS  
**EXACTING STANDARDS**  
OF  
*More Set Engineers*  
**THAN ANY OTHER TUBE!**



RAYTHEON makes tubes for the majority of licensed set manufacturers in the United States! For that reason, RAYTHEON tubes not only meet the exacting standards of more Chief Engineers than any other—but they must perform in more diversified circuits than any other tube!

Your RAYTHEON jobber gives you these same standard tubes in sealed cartons for exact replacement in any receiver!

Order RAYTHEON for greater permanent tube profits.



# RAYTHEON

## RADIO TUBES

445 Lake Shore Drive, Chicago, Ill.  
420 Lexington Ave., New York, N. Y.  
55 Chapel Street, Newton, Mass.  
555 Howard Street, San Francisco, Cal.  
415 Peachtree St., N. E., Atlanta, Ga.

**"WORLD'S LARGEST EXCLUSIVE RADIO TUBE MANUFACTURERS"**

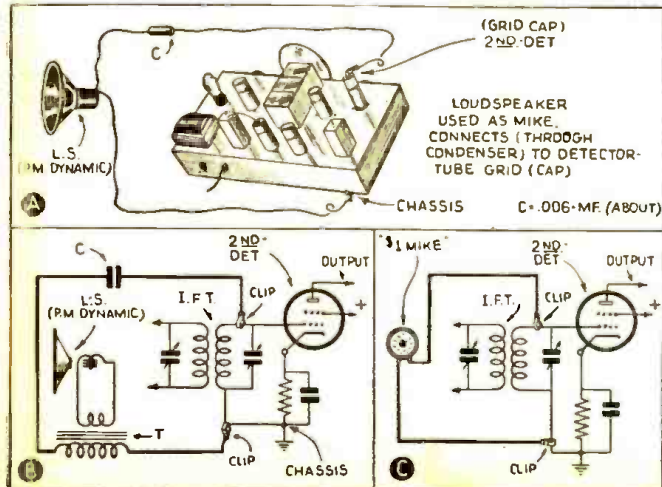

Fig. 3. In A is shown, pictorially, how a loudspeaker (used as a mike), is connected to most radio sets; in B, the schematic diagram of the same connections; and in C, similar connections using an inexpensive carbon microphone.

Please Say That You Saw It in RADIO-CRAFT



# TRAIN FOR ELECTRICITY IN 12 WEEKS

BY ACTUAL WORK ON MOTORS, GENERATORS, ENGINES ETC.

**PAY  
TUITION  
AFTER GRADUATION**

*I'll Finance  
Your Training*



Mail coupon today for details of my "Pay after graduation plan" and famous Coyne "Learn by Doing" method of practical shop training for your start for success in this big-pay field. Age or lack of money need not hold you back... Get training first; then take 18 months to complete small monthly tuition payments starting 5 Months after you begin training.

## LEARN BY DOING IN 12 WEEKS IN COYNE SHOPS

Coyne Training is practical, thorough, easy to grasp... you learn quickly by doing actual

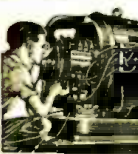

jobs on real electrical machinery in training. Not by books—not a correspondence or a home study course—you are trained right here in my big Chicago training shops. You don't need previous experience or a lot of book learning. Expert instructors guide you every step of the way. Start any time.

## EARN WHILE LEARNING Job Help After Graduation

Big things ahead in Electricity mean steady jobs, good pay, and a real future for the trained man in this fascinating "live" industry. Thousands of opportunities. Rush the coupon TODAY for Big Free Book with hundreds of photos of the great Coyne Shops in Chicago—Opportunities in Electricity—How we can train you for your start in this field and let you pay your tuition after graduation in easy monthly payments. If you need part time work to help out with living expenses my employment department will help you get it. After graduation you will be given Free lifetime employment service.

## DIESEL, ELECTRIC REFRIGERATION AND AIR CONDITIONING TRAINING

Now included at no extra cost. Take advantage of this training to increase your earning capacity.

## GET MY STORY

I have a mighty interesting story to tell about my school that will interest any fellow who wants to get ahead... Fill in the coupon today and mail it to me and you'll get my big FREE Catalog and all the facts. *H. C. Lewis*



**H. C. LEWIS, President,**  
Coyne Electrical School,  
500 S. Paulina St., Dept. 28-78 Chicago, Ill.  
Send me, without cost or obligation, your Big Free Book and details of Pay-Tuition-After-Graduation-Offer.

NAME.....  
ADDRESS.....  
CITY..... STATE.....

(Continued from preceding page)

for a vigorous toot may produce an unwanted shower bath.

**MARCHING FEET**—Marching men require a bit of apparatus. Make a light wooden frame about 18 inches square and run heavy wires across it, about 2 inches apart, in one direction. Take a number of pegs made of inch-square pieces about 3 inches long, and drill a hole through each of them, about a half-inch from one end. Thread them on the wires, keeping them about 2 inches apart by means of beads or lengths of tubing, and see that they all swing freely. That's your army. To make them march, hold the frame in both hands and bring the ends of the pegs down smartly on a table top, lowering one end of the frame before the other.

**SWIMMING**—The sound of a boat approaching or of people swimming can be faked fairly well by dabbling your hands in a bowl of water—a dive by striking the surface of the water in the bowl with your fist. That's a good dive; for one in which the diver lands upon his tummy, strike the water with the palm of your hand. And you'd better wear your bathing suit when you do this, for it's apt to be pretty messy.

**MISCELLANEOUS EFFECTS**—A 10-cent-store siren whistle is good for a wind effect; dried peas dropped onto a tin pieplate simulate rain; baking powder crunched in the hand simulates a person walking in snow. Thunder is obtained by shaking a big sheet of metal, such as galvanized iron; and the roars of wild beasts by punching a hole in the bottom of a tin can, knotting a string through the hole and pulling the string through a resined cloth while the can is held in the other hand near the mike.

Other sound effects may be invented as needed, and you needn't be a second Edison, either.

### PROGRAM SCRIPT FOR HOME- BROADCAST BEGINNERS

Now, as to the script, suppose you combine 3 or 4 popular programs and thus get, let us say, "Warden Blowes", 20,000 Years on Slow Boat's Ham-ateur Hour."

Brace yourselves, here it comes:

**MAJOR:** Hel-lo everybody, this is Katie. No, that's wrong. This is the Slow Boat, and it's only the beginning, folks, only the be-e-e-gin-nin-g. And that's your hard luck. I'll bet you wish it was the end already, don't you? Well, round and round she goes—and comes out here! Tonight we present that gripping drama of prison life called "Gun With the Wind", with an all star ham-ateur cast.

Seated in a waterfront saloon are Bloody Amouse, and Mandy the Avenger, two of the most murderous murderers in Oshkosh, our honor city for tonight. (Calling) Oh water boy! Water boyhoy. Oyoyoy.

#### SOUND EFFECT—WATER

**AMOUSE:** Now you listen here, Mandy. I got big ideas. No more Tommyguns for us. We's got to control de taxicrab racket. We's gonna use airplanes. Airplanes and bombs.

**MANDY:** We's going to use what?

**AMOUSE:** Airplanes. You know. Airplanes. Like this.

#### SOUND EFFECT—AIRPLANE

**MANDY:** (Sneezes) Ha-chu. I understand. Turn that 'ere plane off before I catches cold.

(EFFECT STOPS) And bums did you say?

**AMOUSE:** No, dumkopf, bombs. Bombs, like in Japan, not bums like in here.

**MANDY:** Oh, you mean bombs like this? (PAUSE) Hey, you sound-effects man.

Where'd you go?

**SOUND EFFECT—FOOTSTEPS APPROACHING**

**AMOUSE:** Here he comes now.

**SOUND EFFECT—BOMB**

**MANDY:** The idiot. He's lost the place. He's one effect slow.

**AMOUSE:** Don't tell him. You'll make him nervous. Get on with the script.

**MANDY:** Oh yes. Here we are. I'll pick it up. What you plan to do?

**AMOUSE:** I plan to be de head one in de taxicrab racket. I got de boys started now.

In one second they're due to drop a bomb on the Akmalagamated Taxicrab company. Listen.

**SOUND EFFECT—STRIKE 3 TIMES, AS OF A CLOCK**

**MANDY:** Boy, what an explosion. And timed to the minute. The clock's just going to strike 8.

**SOUND EFFECT—FOOTSTEPS**

**AMOUSE:** Eight o'clock to the minute. That's some timing.

**MANDY:** Sh-h-h. Shut your big mouth. There's a man walking over to our table.

**SOUND EFFECT—BOAT WHISTLE**

**AMOUSE:** Hello, Mr. Who is you?

**NASTY LAUGH, AFTER WHICH HE SPEAKS IN AN EFFEMINATE VOICE.**

**SHADROE:** Heheheh. I'm the Shadroe. The Shadroe knows.

**MANDY:** Don't sound to me like he knows much.

This sort of thing can continue as long as your patience and that of your audience holds out. You can write it by the yard. But sooner or later, like all ordeals, it must come to an end. So that you don't just leave it hanging in mid-air, here's a suggestion.

**MADAME:** I smell something burning.

**MANDY:** That's the audience; they're burning up.

**SOUND EFFECT—CRACKLE OF FLAMES**

**MADAME:** And I'm getting awful hot.

**MANDY:** It's about time this program got hot.

**SOUND EFFECT—FLAMES NEARER**

**MADAME:** Oooooh, Mandy. I see fire. We'll be killed.

**MANDY:** Then you'll see more flames.

**SOUND EFFECT—FLAMES, BUT GOOD AND LOUD**

**MADAME:** Mandy! Mandy! Save me! Get me out of here!

**MANDY:** Hush your mouth. Just blow that fire out.

**MADAME:** It's too big—I mean the fire. I can't blow it out.

**MANDY:** Do what I tell you. Blow at it.

**MADAME:** You're crazy. It'll make it burn more. What do you want me to blow for, anyway?

**MANDY:** So that I can give a blow-by-blow description of it!

**SOUND EFFECT—GONG. (HIT A BIG POT—not the Madame—HARD)**

**MAJOR:** All right, all right. You were just a little nervous that time. Come back and try it again some time—in 1946. And now to return to the list. There are 5,907,652 votes for Amouse, 5,907,653 votes for Mandy—and 24 votes for Underwood! Good night, everybody, and goldurn you.

**ANNOUNCER SIGNALS AUDIENCE** (holds aloft a large card on which is written "APPLAUSE") FOR WILD APPLAUSE.

## NEW EQUIPMENT FOR ALL-WAVE RADIO

(Continued from page 471)

**Ultra-Midget Broadcast-Band Variable Condenser.** A variable condenser with a capacity range sufficient for tuning across the entire broadcast band, yet having the small dimensions indicated by comparison, in Fig. H, is now available.

By removing plates from the condenser lower wavelengths may be reached. The rotor plates interleave with the stators, in the usual manner, but the dielectric instead of being air is bakelite (or some such material), in the form of thin washers. Set builders who go in for the "ultra-tiny" will welcome this long-wanted tuning unit. (1564)

## PREVIEW OF 1938 FASHIONS —SUCCESSFULLY TELEVISED!

(Continued from page 457)

National Broadcasting Company, prior to the demonstration, "we feel sure television will be able to perform great service in the fashion field."

After the demonstration, the audience agreed. This 1938 show by television—forerunner of "Christmas shopping, from the depths of your easy chair, made easy by air"—had as honor guests of NBC a group of stylists who 4 days later saw their television-previewed styles "in the flesh" at The Fashion Group's annual style spectacle which attracted an international audience at the Waldorf-Astoria.

Images sent from RCA Building's (Radio City) 3rd-floor television studio, by coaxial to Empire State, were received via radio on the 62nd floor.

Please Say That You Saw It in RADIO-CRAFT



### NEW CONDENSERLESS TUNING SYSTEM DEMONSTRATED!

(Continued from page 461)

slider contact a little 2-wheeled "trolley car" design (as shown in Fig. 1C and E) is used. The "car" carries, half-way between the wheels, the contact which is made of a sturdy alloy of phosphor-bronze. A guide rod (see Fig. 1A) installed parallel with the main-coil presses the trolley car against only 1 turn of the winding or coil (which is wound on a rotatable cylinder); and presses the phosphor-bronze contact against the spaced turns of the rotating coil, which is wound with heavily silver-plated copper wire.

Another interesting detail of design is revealed in Fig. 1E. The side walls of the 2 little bakelite wheels of the trolley car extend into the narrow space between adjacent turns. In short, the turns are used as shown in Fig. 1E to guide and to move the trolley car back and forth along the coil, turn by turn.

#### THE "INDUCTANCE-TUNED" CIRCUIT

Everything else is simple. We see in Fig. 1F a standard tuning circuit with fixed inductivity but variable capacity, and as comparison an inductance-tuned circuit. The padding condenser P shown in Fig. 1B has been omitted in order to simplify the circuit. Methods for coupling the antenna with this type of tuning circuit are shown in Figs. 1G and 1H. The use of an inductance-tuned circuit for interstage coupling is shown in Fig. 1I. Similar circuits for the converter stage of a superhet. receiver are available. (N.B.—Unfortunately, the condenser shown fixed, in Fig. 1F, should have been shown variable. —Editor)

#### RANGE: 545 METERS TO 175 METERS

Finally, a word about the waverange covered. As the designer explains, one is able to cover with a single coil the entire broadcast and police range (545 meters to about 175 meters). By application of 2 variable tuning coils per stage (see arrangement of Fig. 1D) and the use of a waveband switch one is able to cover the quite extensive range from about 550 kilocycles to 60 megacycles.

A receiver with such a large waverange, as demonstrated at the lecture, is shown in Fig. 1J and 1L. One sees in the center of the chassis the shielded set of coils which are of similar design as those shown in Fig. 1A. The only difference is that 2 tuning coils have been installed in every compartment. It may be of interest to notice that the 2 tuning coils are installed parallel to each other (as shown in Fig. 1D) and are tapped by the same trolley car. This car is of course equipped with 2 separate phosphor-bronze contacts.

#### 20-FOOT SCALE ELIMINATES A.F.C.

Of especial great interest is the extremely large tuning scale (see Figs. 1J and 1K) designed in the form of a spiral having a length of approximately 20 feet. A dial window which moves automatically up and down is used to simplify the reading of the scale.

The extensive length of the tuning scale is of great interest for designers of "electric tuned" receivers, because it provides possibilities to obtain split-hair tuning without the use of the troublesome A.F.C. circuits!

It is known that customary motors will stop within a range of plus or minus 1/16-inch. Although 1/16-inch seems not much to talk about it means nevertheless 3° to 5° on the usual tuning dial, or—when expressed in terms of frequencies—a tuning deviation of 2,000 to 5,000 cycles. Now let us compare 1/16-inch in relation to a scale of a length of about 20 feet. Expressed in frequencies this 1/16-inch now means hardly more than 300-400 cycles, and a better adjustment can hardly be obtained with the average A.F.C. circuit.

There remains only one fact to be mentioned, the price of the new tuning device; which is, according to Mr. Ware, about the same as that asked for a set of tuning circuits for the waverange from 540 kc. to 65 mc. but equipped with fixed coils and a variable condenser.

Be on the look-out for the March issue—the Jubilee Souvenir Number!

# A TREMENDOUS OVATION FROM FAMOUS MEN IN RADIO ENGINEERING!

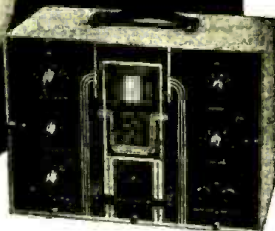

"Model 581 Signal Generator is a distinct and important contribution to rapid, intelligent and scientific radio service work."

*Alfred A. Shirardi*  
Radio Technical Consultant  
RADIO & TECHNICAL PUBLISHING CO.



"Supreme is to be congratulated on the fine instrument they have built in the Model 501 Tube Tester."

*Roy L. Reynolds*  
Field Engineer  
RAYTHEON PRODUCTION CORP.

EMINENT men in radio engineering, used to testing instruments costing thousands of dollars, have given their unqualified approval to SUPREME instruments. Such a tremendous ovation from the men who know, is a mighty tribute to SUPREME quality and laboratory-like accuracy! Such an enthusiastic reception means only one thing—SUPREME instruments must be good!

Your parts jobber is now showing the entire new 1938 SUPREME line. Go see him. You'll find an array of SUPREME instruments you'll be proud to own—and easy to buy on SUPREME S. I. C. terms—the world's easiest installment terms!

**JUST OFF THE PRESS!**  
FREE Illustrated 1938 Catalog. Write for It!

FREE "Adequately Equipped Shop" Certificate  
Send for the free booklet explaining how you can qualify for a Supreme "Adequately Equipped Shop" Certificate.



"In my various experiments, I have found that the Supreme Model 546 Oscilloscope is one of the most complete, accurate, perfectly engineered service instruments I have ever used."

*W. H. Mendum*  
Chief Engineer  
BELMONT RADIO CORP.

## SUPREME INSTRUMENTS CORP.

GREENWOOD, MISSISSIPPI • U. S. A.  
Export Dept.: Associated Exporters Co., 145 W. 45th St., New York City Cable Address: LOPREH, New York

### Once in a Lifetime!

Turn NOW to the advertisement which appears on the inside front cover—you'll find out what the mystery is all about—it happens only once in a lifetime.

Ask your JOBBER for the NEW



### "HAMANUAL"

New Tubes . . . New Circuits  
16 NEW TRANSMITTERS  
5 WATTS TO 1000 WATTS  
STANDARD TRANSFORMER CORPORATION  
850 BLACKHAWK STREET, CHICAGO

Please Say That You Saw It in RADIO-CRAFT



## TELEVISION STUDENTS LEARN BY MAKING CATHODE-RAY TUBES

(Continued from page 462)



**CARTER PARTS**  
**PRICED**  
**SO YOU CAN MAKE MONEY**  
**DESIGNED**  
**TO SAVE YOUR TIME**



**VELVET ACTION**  
**Volume Controls**  
 Rheostat and Potentiometer types. Carbon and wire-wound. Values to cover all replacement requirements.



**SWITCHES JACKS-PLUGS**  
 Uniformly tempered springs retain proper tension permanently. Positive, non-corrosive contacts.



**VITREOUS ENAMEL RESISTORS**  
 Entire unit porcelain covered. Carefully wound for long life and true values. Stock sizes from 10 to 200 watts.

It's EASY to get parts that give complete satisfaction with less expense. Just say "UTAH" to your jobber. Address department RC-2 for catalog on parts that simplify replacement service.

**CARTER DIVISION**

**UTAH RADIO PRODUCTS CO.**  
 CHICAGO, U. S. A.

TORONTO ONTARIO, CANADA      BUENOS AIRES (UCOA RADIO PRODUCTS)

**'16 YEARS OF LEADERSHIP'**

# RADIO ENGINEERING

broadcasting, aviation and police radio, servicing, marine radio, telegraphy and telephony, Morse telegraphy and railway accounting taught thoroughly. Engineering course of nine months' duration equivalent to three years of college radio work. All expenses low. Catalog free. School established 1874. Dodge's Institute, Hudson St., Valparaiso, Ind.

**RADIOS.. SAVE UP TO 50%**

DEAL DIRECT...FACTORY PRICES! Many models to select from: AC-DC; All-Wave; armchair models; automatic tuning; car radios; Farmsets that operate like city radios! Send postcard for NEW Bargain Catalog FREE. 30-DAY TRIAL plan and agent-user proposition! GOLDENTONE RADIO CO. DEPT. B2, DEARBORN, MICHIGAN.

Free Catalog

30 DAY TRIAL \$6.98 UP

**JUBILEE SOUVENIR NUMBER**  
**MARCH, 1938 RADIO-CRAFT**  
 See Inside Front Cover for Details

cathode now is placed another cylinder (C), the end of which has a hole which is smaller than the emitter-end of the cathode. Again, in front of this second cylinder is placed the first anode (D) which has a hole in its center smaller than that in the second cylinder. The other electrode is of course the graphite coating (described in a preceding installment) on the inside surface of the tube.

It is very important that the holes in these electrodes be properly aligned with respect to the cathode if any suitable spot of good intensity is to be obtained upon completion of the tube. Furthermore, unless the electrodes are very rigidly mounted they will be warped out of alignment during the subsequent "bombarding" procedure in the process of evacuation later on. The insulating material used to properly align the electrodes and hold them firmly in place is *isolantite*. Although this material has considerable gas combined in its structure it was found that, by prolonging the heating process when degassing the tube later on, all gas could be driven off. Glass supports are used wherever possible and the design of the electrodes so arranged that the metal wires require a minimum amount of insulating structural material to help keep the parts of the gun in line.

### EVACUATING THE TUBE

We found that the cathode-ray tube had to be exhausted more carefully than nearly any other tube with which we ever worked. The magnitude of this problem was surprising.

The metals comprising the electron gun had to be heated close to their melting point if they were to be made to give up their gases readily. The same was true of the gas envelope as well as the insulating material supporting the structure of the gun. The process required simultaneous sustained heating and pumping; and the use of mercury vapor and liquid air to remove all traces of air and other gases. The entire set-up is shown diagrammatically in Fig. 2.

The evacuating system, which after considerable experimentation we found to be suitable, consists of an *oil pump* "in series" with a mercury-vapor pump or *aspirator* as it is called. The operation of the system is as follows:

The oil pump, by means of suction, draws as much air as possible out of the cathode-ray tube. Yet, by its best possible action, it cannot create a vacuum sufficiently good for television work. Therefore, to aid the oil pump the mercury aspirator is used. Both pumps work simultaneously.

The mercury (which in its natural state is a liquid metal) in chamber A (Fig. 2) is heated by an *electric heater* until it boils-off into a vapor. The mercury molecules in their gaseous state are in a state of vigorous vibration due to the heat which they have absorbed from the electric heater. By virtue of their intense vibration, they collide with the air molecules, carrying them along up towards the *suction tube* (C)

of the oil pump.

As both gases (mercury vapor and air) rise into chamber B, the mercury vapor is condensed by means of the cold water circulating in the *water jacket*. The air molecules, however, due to the tremendous momentum, imparted to them by the action of the mercury vapor molecules, are carried up into the suction tube of the oil pump and hence removed from the system—and from the cathode-ray tube.

The overall effect of the mercury aspirator, therefore, is to aid the work of the oil pump by increasing the velocity of the air molecules, thereby permitting a more complete evacuation of the cathode-ray tube.

### THE LIQUID AIR "COLD-TRAP"

During the operation of the mercury aspirator it is inevitable that some of the mercury vapor should "kick back" or diffuse through the system and eventually find their way into the cathode-ray tube... unless it is caught in some manner. To prevent such a condition, a *cold-trap* is incorporated in the set-up to ensnare the mercury vapor by condensing it into liquid form. The cooling medium used for this purpose is *liquid air*.

### THE HIGH-FREQUENCY OVEN

While this pump action is in progress, both the glass envelope of the cathode-ray and the electron gun are being heated to close to their respective melting points, the object being to drive off any gas which may be imbedded in their structures. While it is easy enough to heat the tube by means of a flame, the problem of heating the internal metals constituting the electron gun was solved by using *high-frequency currents*.

A coil of wire carrying these currents is placed around the neck of the tube immediately surrounding the electron gun. Due to eddy currents and hysteresis in the metal, they become heated. All gases thus liberated are drawn off by the vacuum pumps.

After the tube had been pumped for the first half-hour, the filament (and hence the cathode) was heated, both giving off large volumes of gas. The barium and strontium carbonate together with the binding material also give off large quantities of gas, specifically *carbon dioxide*.

After another half-hour, the first cylinder was charged with a small positive potential so that electrons emitted by the cathode were attracted to it, developing a thermionic or electron current. The positive potential on this electrode was gradually increased until the filament current started to show an increase without further increasing the positive potential on the anode. It was then allowed to remain at this potential until no further increase in current was evident over a period of several minutes.

The next cylinder or *anode* was then charged positively and a stream of cathode-rays projected on the screen, yielding a bright green

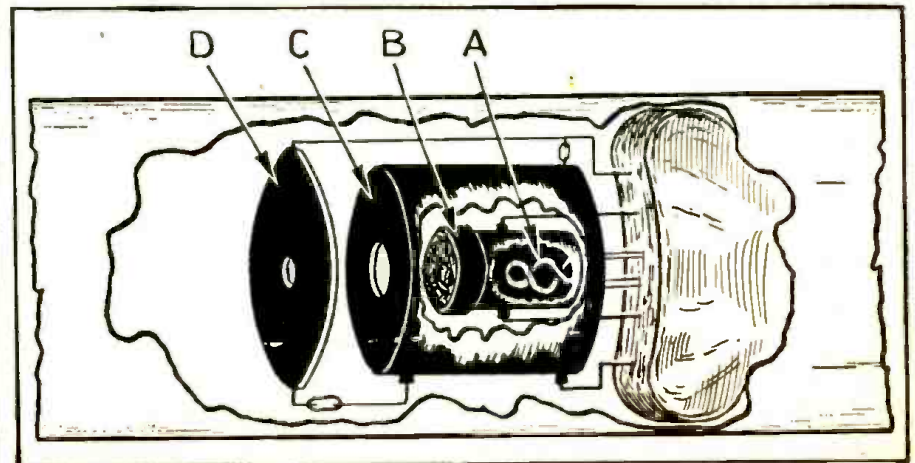

Fig. 3. Showing construction of the electron "gun". A is the tungsten filament; B is the electron emitter; C and D, focusing electrodes. The graphite coating (see text) is also an electrode.

Please Say That You Saw It in RADIO-CRAFT



fluorescent spot. At this stage, the walls of glass rapidly collected a negative charge which was disbursed by charging the graphite coating with a positive potential. Continued bombardment of the screen freed additional gas which was drained by the pumping system. After several hours, all trace of gas disappeared, even when the anode voltages were raised to several thousand volts.

**FOCUSING THE CATHODE RAYS**

We then proceeded to investigate how we could focus these cathode rays and vary their intensity.

It was apparent that here we had a tool which was similar to the combination of a (1) "projection system," (2) "scanning system," and (3) "light valve," speaking in mechanical-television language. We could place a focusing magnetic coil in front of the electron gun and focus the divergent stream of electrons down to a point,

or by raising the potential of the aquadag coating over that of the first anode, we could also focus the cathode ray to a point. We could deflect the electron stream considerably with either the smallest magnetic force held near it, or an electrostatic charge.

From this point on, it then remained for us to increase the intensity of the cathode ray, and to vary the intensity of the spot without varying the spot size and also, to learn the factors governing the size of the aperture, and cathode, and the ratio of these various sizes, distances and potentials.

How we obtained the desired results, and the type of gun finally decided upon (which is practically identical in function with a good optical projection system), will be the subject of our next article.

*This article has been prepared from data supplied by courtesy of American Television Institute.*

**60 TONS OF ANTENNA**

*(Continued from page 462)*

many thousands. A modest experiment in one room has helped found a billion dollar industry. A world of entertainment and information, undreamed of a few short years ago, is at the constant beck and call of everyone at no charge other than the initial cost of a radio receiver.

**MAIN ANTENNA HAS 8 "SUPPRESSOR" ANTENNAS**

The principal elements of the new antenna system are the main antenna, a steel spire towering 718 ft. high, and a circle of eight 90-ft. antennas designed to suppress interfering waves normally emitted in radio transmitting. (See Fig. 1.)

Vertical antennas of this type radiate both ground and sky waves. When these two waves meet in areas of varying distances from the station they interfere with each other causing fading, or mushy program reception. The ring of shorter towers also radiates sky waves but in opposite directions to nullify the effect of the sky wave emitted from the main antenna. The fading zone is thus extended to great distances from the station, and broadcast reception

is thereby vastly improved.

The 60-ton structure rests in the ball-and-socket joint of a single large porcelain insulator, strong enough to support the weight of the steel tower, plus about 20 tons additional load added by the pull of the guy wires.

Completely insulated from the ground, the steel spire becomes charged with static during storms, then crackles and sparks continuously across a spark gap to ground. Such electrical phenomena have no effect on broadcasting efficiency.

To improve the conductivity of the ground around the antenna, about 50 miles of copper wire have been buried a foot under the surface, radiating out, one degree apart, for 700 feet. The vast, efficient ground system so formed aids in reducing the effect of sky-wave emissions.

Though now the highest welded structure in the world—nothing is close to it in slim height—the antenna was erected in 72 working hours by a crew of 9 men. Its top light beacon and lightning rod is level with the roof of the Radio City building in New York, whence come many of the NBC network programs broadcast by KDKA.

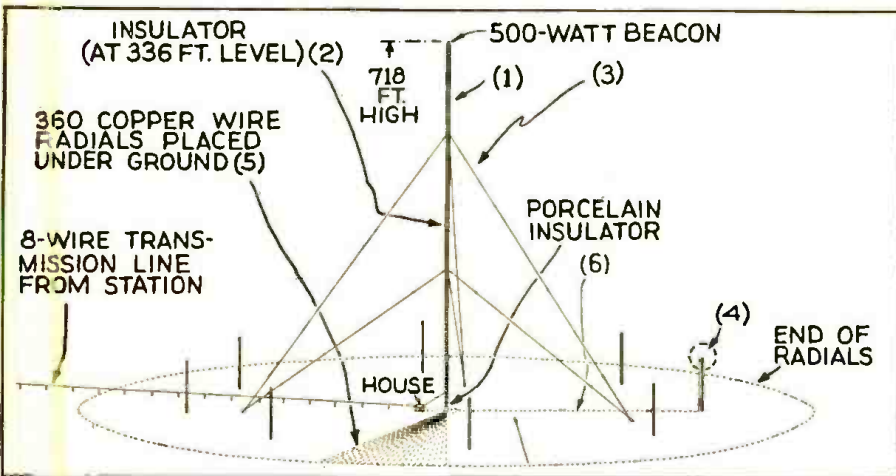

Fig. 1. This triangular steel tower (1) measures 5 1/2 ft. between legs. A ladder inside the tower extends its full length. The entire tower is supported at its base on a porcelain insulator. The 336-ft. level of the tower is broken by an insulator (2). The 6 steel guide wires (3) are broken at intervals by insulators. Each of the 8 wooden poles, 90 ft. high, forming a circle around the tower, supports a suppressor antenna of copper tubing as shown by the typical example (4) encircled in dotted lines; each suppressor antenna is fed power by means of an underground concentric cable transmission line, as shown by the typical example (6). These poles are located 504 ft. from the base of the tower. Each of the underground radials (5) is 700 ft. long. These radials are spaced 1 degree apart, starting at the base of the tower, and form a complete circle as shown by dotted lines. These radials are constructed of No. 8 copper wire and make a total length of approx. 48 miles.

**Make More Money in RADIO!**  
**I SET YOU UP... Ready for Business and Profits!**

This is the time to cash in on the most sensational home training method in the history of Radio... for here is an industry that is making fortunes for live, wide awake men.

**I Can Teach You Quickly No Previous Experience Required**

This new and different kind of home training does more than teach you about all branches of Radio. It teaches you modern Radio business methods. It sets you up for an actual start in business. It backs up every step of your training with practical experience through the use of REAL PROFESSIONAL Radio equipment. You will be amazed how quickly you will grasp the fundamentals of modern Radio as it is clearly, concisely and interestingly presented in MY course. Will thoroughly fit you for a useful and profitable career in Radio servicing or in broadcasting, commercial Radio, public address systems, aviation Radio, etc.

**THESE GRADUATES ARE ENJOYING RAPID ADVANCEMENT... WITH BIG FUTURE AHEAD**

Edwin A. Gammon, Auburn, Me., writes: "Your Course is so thoroughly good and practical that it is hard to pick out one part that is better than any other. Due to the knowledge I have gotten from it, I have been deluged with work for the last month, achieving good results with Radio's which had been unsatisfactorily tackled by other servicemen. You deserve all the credit."

"Cleared" \$150 in Spare Time  
 A. H. Lanole, Northbridge, Mass., writes: "Since enrolling I have cleared a net profit of more than \$150 in spare time alone... and I am not one-half through the course yet. Honestly, I cannot understand how you can give so much 'dope' for so little money."

Very Practical Course  
 Walter Davis, Baltimore, Md., writes: "I am now making on an average of from \$10 to \$25 a week in spare time work and may go in for full time Radio servicing and sales. This proves to me that the Sprayberry Course (for which I would not take anything or any price) is very practical."

**BIG PROFESSIONAL OUTFIT GIVEN**

No matter what kind of Radio training you take, it is absolutely necessary that you have equipment of this kind before you are ready to start making real money. YOU GET A THREE-IN-ONE TESTER, RIDER MANUA'S TOOL KIT, ELECTRIC EYE OUTFIT AND EXPERIMENTAL APPARATUS. Upon completion, you have business experience and technical Radio training plus needed equipment to enter business for full or part time profits.

**MAKE MONEY WHILE YOU LEARN**

I GIVE YOU SPECIAL RADIO BUSINESS BUILDERS WHICH SHOW YOU HOW TO GET SPARE TIME RADIO JOBS AND HOW TO DO THEM. You certainly owe it to yourself and to your future to investigate this unusual type of Radio training before enrolling in any course.

**SPECIAL SERVICEMEN'S COURSE**

... Of an advanced nature for men already in Radio work. Radials newest methods, circuits and short cuts. Terms low as \$3.00 per month.

**GET THE FACTS!**

**Mail Coupon Now**  
 Sprayberry Academy of Radio,  
 F. L. Sprayberry, Pres.,  
 120-B University Place, N. W.,  
 Washington, D. C.

Please send me free copy of "More Money in Radio".  
 Name ..... Age .....  
 Address .....  
 City ..... State .....  
 Mail in envelope or paste coupon on postcard.  
 If interested in Service Course only, check here ( ) .

**Radio is 50 years old!** How far back can you remember? See the March JUBILEE SOUVENIR NUMBER.

Please Say That You Saw It in RADIO-CRAFT



## HOW TO MAKE THE RADIO-CRAFT SUPER-DELUXE 30-TUBE SET

(Continued from page 469)

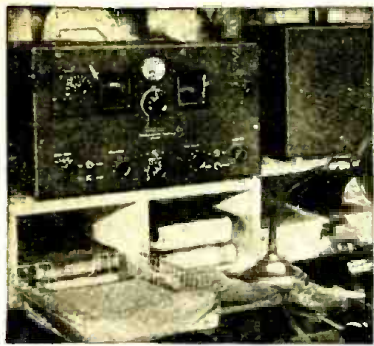

### 'PERFORMANCE IS TIP-TOP!'

"WITH our 'Super-Pro' receivers, we are able to constantly maintain unusually difficult schedules running 16 hours a day," says Stanley Wolff, chief operator, New York Herald Tribune wireless station. Mr. Wolff continues, "Day or night, rain or shine, these receivers are 'on their toes' offering tip-top performance." "Super-Pro" receivers feature 2 R.F. on all bands; electrical hand spread; calibrated panel controls, etc. Mail coupon for further details!

HAMMARLUND MFG. CO., INC. RC 2-38  
424-438 W. 33 St., N. Y. City

Please send me "38" catalog.

Name .....

Address .....

City ..... State .....



**HAMMARLUND**

Canadian Office: 41 West Ave. No., Hamilton, Ontario

# Save Money on everything you buy...



## The New BARGAIN BULLETIN

Your Guide to Hundreds of Outstanding Values.

**FREE** Write today for this outstanding new BARGAIN BULLETIN—there is no obligation on your part. High quality merchandise at sensationally low prices! Radio Sets, Parts, Sporting Goods, Watches, Clocks, Typewriters, Cameras, Novelties and many other items at real savings to you. Fair Dealing—Prompt and Courteous Service, always. Send for your Free BARGAIN BULLETIN now, try us, and be convinced of our superior values and service.

**RADIO CIRCULAR CO., INC.**  
DEPARTMENT RC  
915 Broadway New York, N. Y.

### RADIO COURSES

RADIO OPERATING: Prepare for Gov't License Exam. ● RADIO SERVICING: Including Short Wave ● AMATEUR CODE ● ELECTRONICS ● TELEVISION ● Day and Evening Classes—Booklet Upon Request  
**New York YMCA Schools**  
4 W. 64th Street, New York City

alignment. Adjust trimmers No. 1 to No. 6 (see Fig. 16A) for maximum reading or height on the screen, in numerical order. Reduce signal generator output as required if reading goes off-scale.

**SECOND STEP.** Leave all connections as they were, but change the setting of the signal generator to 456 kc. Adjust trimmer No. 7 for maximum reading.

**THIRD STEP.** Remove signal generator leads from 2nd I.F. tube and replace grid cap. Connect signal generator to cap of 6L7 (V2), mixer, on Chassis No. 1. Be sure to remove the variable condenser grid lead from the cap of this tube. With the signal generator set at 456 kc. adjust, in numerical order, trimmers No. 8-9-10 and 11 for maximum reading. (Refer to Fig. 2A.) It may be necessary to reduce the output of the signal generator several times during alignment and in any case use the weakest signal obtainable that will produce a visible reading.

**FOURTH STEP.** Trimmer No. 12 should be adjusted to give a minimum reading at 10 kc. However, this trimmer requires the use of an audio frequency oscillator, which should be connected from the grid of the 1st A.F. tube, 6C5 (V18), to chassis. If this oscillator is not available, simply turn the trimmer screw all the way out, so that the metal plates are tightly pressed against the mica sheets.

The knob (No. 13 trimmer) on the B.F.O.

transformer is adjusted to produce a note of about 1,000 cycles.

Due to the extreme sensitivity of the set, it is possible that overload may occur in the R.F. or I.F. stages when tuning in nearby stations. It is advisable in such cases to set the DX-Local switch to *Local* and to set the bandwidth switch to *Broad*. It may even be necessary to disconnect the antenna from the set altogether, to prevent overloading when receiving very powerful local stations.

The operator will have to practice the manipulation of all the controls in order to obtain maximum results; especially important are the Noise Silencer and A.V.C. level settings.

### THE ANTENNA

The receiver works best with a *doublet* antenna. There are several excellent types on the market at present, but if the reader wishes to make his own the following data may be used (see Fig. 16C). Measure off 2 lengths of bare or enameled *solid* wire (No. 14 gauge) of 30 feet. Attach one end of each length to a glass insulator and *solder* to each of these ends one leg of the twisted pair of wires which constitute the transmission line, which should not exceed 75 feet in length. No matching transformers are required for this type of aerial, simply connect the 2 leads of the transmission line to the antenna and ground binding posts on the multi-wave tuner.

### TABLE OF OPERATING VOLTAGES

NO.	TUBE	USE	CHASSIS NO. 1					Inj. G
			III	K	CG	SG	P	
V1	6K7	RF	6.1	1.5	—	80	200	—
V2	6L7	Mixer	6.1	4.1	—	100	180	—
V3	6J7	Osc.	6.1	0	—	125	150	—
V4	6E5	A.F. Ind.	6.1	8	—	—	200 (on target)	—
V5	80	Rect.	5.1	300 at fil.	—	—	200 (on target)	—
V6	6G5	Tuning	6.1	—	—	—	200 (on target)	—
V7	6E5	Sens.	6.1	—	—	—	200 (on target)	—
CHASSIS NO. 2								
V8	6J7	N. Amp.	6.1	2 to 35	—	95	200	—
V9	6H6	N. Rect.	6.1	0 to 35	—	—	—	—
V10	6K7	A.V.C. Amp.	6.1	12	—	95	200	—
V11	6H6	A.V.C. Rect.	6.1	0 to 40	—	—	—	—
V12	6K7	1st I.F.	6.1	5	—	95	180	—
V13	6L7	2nd I.F.	6.1	4.5	—	95	190	-22
V14	6L7	3rd I.F.	6.1	9.	—	95	190	-5
V15	6C5	2nd Osc.	6.1	0	-22	—	160	—
V16	6C5	B.F.O.	6.1	0	-2	—	25	—
V17	6H6	Dem.	6.1	0	—	—	0	—
V18	6C5	1st A.F.	6.1	2.	—	—	65	—
V19	6R7	2nd A.F.	6.1	0	-6.	—	105	—
V20	6K7	Bass Amp.	6.1	0	-3.	24	55	—
V21	6C5	Bass Amp.	6.1	0	-5.	—	140	—
CHASSIS NO. 3								
V22	6C5	3rd A.F.	6.1	0	-8.	—	150	—
V23, 24	6C5	P.-P. A.F.	6.1	0	-8.	—	140	—
V25, 26, V27, 28	6L6	P.P.-P. A.F.	6.1	0	-25.	295	405	—
CHASSIS NO. 4								
V29	83	Rect.	5.0	435 at fil.	—	—	—	—
V30	5Z3	Rect.	5.0	305 at fil.	—	—	—	—

### ANSWERS TO QUESTIONS ON EXPERIMENT 5A—See page 488

1. A short-circuit is so called because the current path offered by it is: (*low in resistance*).
2. In the continuity test with phones, the *primary* of an audio transformer gives the louder click.
3. In the above test, if no click is obtained, it is an indication that the circuit is: (*definitely open*).
4. In the above test, a condenser is shorted if we obtain: (*repeated clicks*).
5. In using the short-circuit test with a bulb, on a high resistance (in this case anything between 100 and 1,000,000 ohms), if the bulb lights, it is an indication that the circuit is: (*definitely shorted*).

### SERVICING INSTRUMENTS FOR 1938

(Continued from page 476)

maximums are as follows: 2,000 V. D.C. (25,000 ohms/volt); 2,000 V. A.C. (1,000 ohms/volt); 500 milliamperes D.C., to 20 amperes; 0-500 low-ohms (backup circuit), to 20 megohms; 0.001- to 30 mf.; -10 to +15; free-point series and parallel meter connections. (1534)  
(The Triplett Electrical Instrument Co.)

**5,000 Ohms/Volt Multirange Meter.** The low drain of the meter, often less than 50 microamperes, permits accurate determination of voltage, in a new multirange unit designed for the radio and electrical appliance trade. Maximum ranges are: 600 V. A.C. and D.C.; 15 ma. D.C.; 1½ megohms. with self-contained battery and up to 15 megohms. with external battery. (1535)

Please Say That You Saw It in RADIO-CRAFT



**LET'S PEEK IN AT TELEVISION WITH TWO OF ITS LEADERS**

[DAVID SARNOFF]

(Continued from page 457)

The B.B.C. (British Broadcasting Corporation) has been operating its television transmitter, located at Alexandra Palace in London, for about a year. The range of the transmitter is more than 25 miles and covers all of London and its immediate vicinity. The system employed is known abroad as the Marconi E.M.I. Television System which is fundamentally based on the RCA Television System first developed in the RCA Laboratories in the United States. Under an exchange of patent licenses, this British Company may use RCA patents in England and in turn, RCA and its American licensees may use British Patents in the United States.

Each side is therefore in a position to benefit from developments and improvements made by the other.

For nearly one year the B.B.C. has been broadcasting television programs to the public on a regular daily schedule of one hour in the afternoon and one hour in the evening.

Some 15 British radio manufacturers have been offering television receiving sets to the public at prices ranging between \$200 and \$500 each. At the Olympia Radio show which I visited while in London, all the manufacturers exhibited their latest television sets and the B.B.C. arranged special programs so that the public could view the actual operations of television while visiting the radio show. From a technical standpoint the results were highly satisfactory. The public filled the television booths and showed great interest. But while hundreds of thousands of ordinary broadcast receivers were sold during the show the public bought less than 100 television receivers in total.

During one year's operation of a public television service in England, less than 2,000 receivers in all have been sold to the trade and less than 1,000 are actually in the hands of the public. There is but one television transmitter in London, and I was informed that it will probably be 2 years more before a second transmitter is erected in any other part of England.

**U. S. AND BRITISH PROBLEMS FUNDAMENTALLY SIMILAR**

The foregoing represents the present status of television in England despite the fact that geographically its problem is simple compared with the vast area to be served by a television service in the United States. Also it is to be noted that in England the costs of erecting a television station, the establishment of a special organization, and the furnishing of television programs, have been paid by the Government out of license fees paid by the public annually for the privilege of listening or seeing by radio.

The range of the RCA television transmitter atop the Empire State Building now operated by the NBC from its television studios in the RCA Building in New York City, is approximately the same as that of the B.B.C. station in London. The television receivers installed in the homes of our experts, who have been carrying on field tests during the past year, are likewise of the same order of performance as those in use in England.

The major problem of television, in both countries, is to provide a program for the home that will meet public requirements and maintain public interest.

To place television on a commercial basis in the United States, it is necessary to establish a sufficient number of sending stations, that must be interconnected and able to furnish a regular service at least to the population residing within the principal market areas of our country. The erection of such stations, the provision of necessary interconnecting facilities, and the establishment of a regular program service that would meet public requirements and hold public interest, call for vast financial expenditures before any returns can be reasonably expected.

I firmly believe in the American System of private enterprise, rather than Government subsidy; of free radio to the home, rather than license fees paid to the Government by owners of receiving sets; and I have no doubt, that in due time, we shall find practical answers to the practical problems that now beset the difficult road of the pioneer in television. The road calls for faith and perseverance as well as ingenuity and enterprise but it is a road that holds great promise for the public, for artists and performers, and for the radio industry.

**WILL YOU TAKE THIS PORTABLE RADIO SERVICE LABORATORY as a GIFT from NATIONAL UNION?**

(Special Offer Expires February 15th)

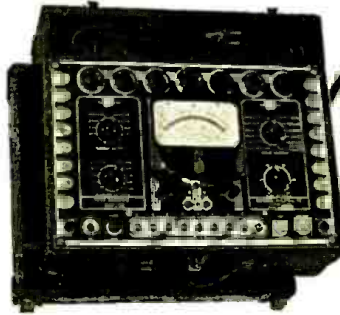

*the*  
**NEW Simpson**  
**"TEST MASTER"**  
MODEL 440

**If you bought it you'd pay \$59.00 but you can have it FREE\* with N. U. Tube and Condenser purchases!**

Ruggedly constructed to Simpson quality standards. Own a Test Master the easy N.U. way.

**FOR SET TESTS**

- 6 AC-DC Voltage Ranges
- 4 Current Ranges
- 6 Decibel Ranges
- 1 Ampere Range for automobile test work.

Here in this 12-pound, compact, high-efficiency unit are all the features the Service Engineer

**FOR TUBE TESTS**

Tests special types without adapters. Tests for noise. Tests all types regardless of filament terminal location. Tests screen fluorescence and angle on tuning indicator types. needs to test tubes and analyze radios in the home.

**\* You deposit only \$29.75 during SPECIAL — SAVE! ACT NOW**

**QUALITY! NATIONAL UNION'S BYWORD**

So many thousands of Radio Service Engineers have proved National Union quality in the field that it is taken for granted. Due credit however should be given to the large staff of research engineers who are constantly at work in the

National Union Laboratories striving to improve N.U. Products and develop new and finer merchandise. The N.U. research staff is your assurance that National Union Products will never let you down.

**THE ROAD TO BETTER BUSINESS**

- 1. Full guarantee on highest quality radio tubes.
- 2. Cut price business not solicited.
- 3. Price Protection.
- 4. N.U. jobber stocks are complete...No hunting for odd types.
- 5. Timely business building aids.

National Union Radio Corporation RC-238  
570 Lexington Avenue, New York, N. Y.

Who's the nearest N.U. distributor?

Send details of Jan. special .....

Name .....

Street .....

City ..... State .....

**SPECIAL RADIO OFFER**  
**IMPERIAL EASY-TO-BUILD RADIO KIT**  
All parts ready to wire up and plug in.

Complete (less tubes) with necessary fittings, supplies, simple directions furnished with kit. The thrill of a lifetime — so easy even a child can assemble this new type 5 tube radio. Operates on A.C. or D.C. 115 volts. Your individual radio at a fraction of what you'd have to pay at any store.

**5 45** Add 25c Postage

Send 2c stamp for catalog

**IMPERIAL MODEL AERO SUPPLY**  
416T McDONALD AVENUE, BROOKLYN, N. Y.

**PRICES REDUCED**

on two Brush micro-phones — BR2S and B-1. If your jobber can't supply you, write US.

**THE BRUSH DEVELOPMENT CO.**  
3312 Perkins Ave., Cleveland, Ohio

Please Say That You Saw It in RADIO-CRAFT



**"LET ME TRAIN YOU at home FOR A GOOD RADIO JOB"**



**Get in Line for Big Money**  
 A. G. Mohaupt, Directing Engineer, Radio is growing fast. Modern receivers require thoroughly trained experts for service and maintenance. You can become such an expert right at home through R.T.A. methods and begin earning money almost from the start of your course. In a very short time you will

**Be the ONE Man in 1,000**

who understands everything there is to know in order to give quick "sure-fire" service to all kinds of receivers. You can be the one man who can take the service business away from the old-time radio "linker."

**No Experience Needed**  
 Even though you know nothing about Radio now, you can quickly qualify the R.T.A. way to step right into a well-paying position—or start your own profitable business. Use your spare time and

**LEARN AT HOME**

Most R.T.A. members start making money right from the beginning. The special servicing equipment which is supplied without extra cost makes this possible. Don't wait—get started now. Write today for our interesting Radio Book FREE.

**Don't Put It Off—Send Coupon Now**

**RADIO TRAINING ASSOCIATION OF AMERICA**  
 4525 Ravenswood Ave., Dept. RC-28, Chicago, Ill.

RADIO TRAINING ASSN. of AMERICA  
 Dept. RC-28, 4525 Ravenswood Ave., Chicago, Ill.  
 Gentlemen: Send me details of your Enrollment Plan and information on how to learn to make real money in radio quick.

Name .....

Address .....

City ..... State .....

**INCLUDED WITH OUR TRAINING**



This efficient time-saving, trouble-finding Circuit Analyzer and Resistance Tester helps you to make money without delay. Our Free Book tells you how.

**"BIMETALLIC CONDENSER" AIDS TUNING!**

(Continued from page 470)

This reduces the error in alignment, not so apparent to the average set owner, which makes it necessary for most set manufacturers to warn the Service Man to "leave the set turned 'on' for about 15 minutes, in order to enable the chassis to reach normal operating temperature, before starting to make any alignment adjustments."

The design of temperature-compensated tuning circuits as described above is, of course, quite a complicated matter, and is not always solved by the application of such means as is shown by the example in Figs. 1B and 1C. However, one of the major problems involved in the design of temperature-compensated tuning circuits may be solved by similar applications of bimetallic parts of analogous form, as shown in the figures last mentioned.

Finally, there remains but one question to answer: What is bimetal?

**WHAT IS "BIMETAL"?**

Bimetal consists of 2 thin layers of different

metals permanently bonded together throughout their surface of contact. The metals used in the two layers have differing rates of thermal expansion in certain temperature ranges, and this difference in expansion causes the strip of metal to bend as its temperature changes. The particular portion of the temperature range, in which the type of bimetal known as "standard" is employed in radio receiver use, utilized by the bimetallic condenser is shown in the graph, below.

An exact manner in which the new bimetallic trimming condenser is applied to one make of commercial receiver is illustrated in Fig. 1E, which is taken from the set manufacturer's schematic diagram. Here condenser C15 is the bimetallic unit. It is in shunt with the regular circuit trimmer C14, for the broadcast-band coil B. (Condensers C12 and C13 are ordinary—not bimetallic—trimmers, contained inside the coil assembly. They function as padders for the broadcast-band coil. Condenser C11, which also appears in the photograph, is the police-band coil trimmer.)

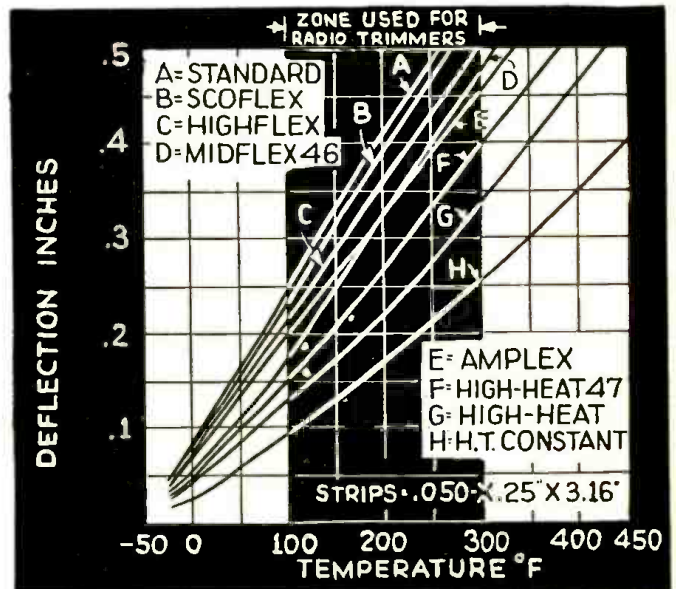

Bimetal "Standard" of 0.02-in. is used in the American radio industry. The diagram shows the deflection (in inches) of test strips of various types of bimetal by application of temperatures, starting with -50° F. and extending to +800° F. The most important range lies in the temperature area from +100 to +300° F. (black area on the graph). A change of +200° F. will cause the "Standard" test strip to deflect 0.55-in.

**MILLION TUBE TESTER**



**FEATURES**

- Emission
- Metal Tubes
- Shorts Hot
- Leakage Hot
- Resistance
- Electrolytics
- By-Pass
- Condensers
- Diagonal Meter

**MODEL CP \$13.95 NET**

MODEL TM \$16.95 Has 3" square meter and continuous line voltage adjustment.

Direct orders require deposit and name of your jobber.

**MILLION RADIO AND TELEVISION LABORATORIES**  
 659 N. UNION ST., CHICAGO, ILL.

**TRADE-IN your old TEST EQUIPMENT**

Liberal allowance against the purchase of any new standard make equipment. Write for full details—mention make and model of your old equipment and the new equipment you desire.

**DALE RADIO CO., Inc.**  
 25 WARREN ST., NEW YORK, N. Y.

**LET'S PEEK IN AT TELEVISION WITH TWO OF ITS LEADERS**

[DR. ALFRED N. GOLDSMITH]

(Continued from page 457)

**RELAY STATIONS WILL HELP INCREASE COVERAGE**

Points in southern parts of the state may not be able to realize successful reception of television images direct from New York, but the terrain of that section is generally flat, favoring utmost "horizon" range from a transmitter in the area, which might be at Philadelphia or at a point in South Jersey, where it would be logical to locate an automatic radio relay to connect the two large cities. Successful experiments in the automatic radio relay between New York and Philadelphia were accomplished, by RCA several years ago, through a single relay station, located at Arney's Mount, near Trenton. This was done with 180-line images, whereas today's standards call for 441 lines to the "picture," but the test was taken to be indicative of future possibilities.

**THE "CELESTIAL ART" IS EXPENSIVE**

The operation of the electronic television system, from pick-up to receiver image, may be called a "celestial art", because the higher the transmitting and receiving antennas, the more ideal are the conditions of operation. The problems of programming television are not the least of its developers' worries; it costs Holly-

wood \$100 to \$30,000 to produce a minute's worth of usable "feature" film for a total of 600 hours entertainment a year. Present sound broadcasting networks render service for upwards of 17 hours each day.

Television must develop its own program technique. If we may summarize the ultimate characteristics of such programs in a word, it should be *spontaneity*. Television must capture images of the world in action.

Television networks of stations comparable to those existing in sound broadcasting must await the development of either (1) the coaxial cable or (2) automatic radio relay stations.

Meanwhile, if public service should be inaugurated, the individual station has recourse to 3 classifications of program material: (1) local talent, (2) motion picture film, and (3) "road shows" of live talent traveling from studio to studio. In the instance of the last, "stock companies" would face the necessity of developing a new make-up technique, since the television camera does not "see" its images in the same values of color and tone as does the eye or motion picture camera.

Upwards of 10 million dollars probably have been expended on the development of television to date, by all experimenters, and current research appropriations may total between 1 and 2 million dollars a year.

Please Say That You Saw It in RADIO-CRAFT



## TELEVISION "PIPED" 100 MILES

(Continued from page 463)

### ECONOMICAL USE OF COAXIAL CABLE

What the demonstration did show for the first time is the unique and economical utilization for television currents of the frequency band of a long coaxial cable.

Instead of transmitting the television currents by the double-sideband method common to radio broadcasting, a method for single-sideband transmission was developed, thus utilizing to the fullest the frequency range for which the cable system was equipped.

The double-sideband method has been used in Europe for transmission of 180-line images over coaxial cable. In that transmission each sideband occupied only about 1/3 of the transmission range of the cable system, amounting to the television use of the available frequency range at only 33 per cent efficiency.

In the method which has just been demonstrated at Philadelphia a single sideband is obtained by (1) double modulation and (2) precise filtering; and this sideband is placed to avoid the first 100 kilocycles of the frequency range of the cable system where transmission is unsatisfactory and the various components cannot easily be amplified (see Fig. 1). There was also introduced compensation for the different velocities of transmission (phase delay, see Fig. 2), of different frequency components. The result is the delivery of an essentially perfect replica of the almost infinitely complex current produced at the sending end by the scanning equipment.

### NEXT STEP—350-LINE IMAGES

These are results never before obtained. As soon as the present experiments are completed the experimental 1,000,000-cycle repeaters on a portion of the cable are to be replaced by experimental 2,000,000-cycle repeaters, as the next orderly step in the development of equipment which will give a coaxial cable system capable of

accommodating the maximum number of telephone channels which it is economical to handle on such a cable or the widest band of frequencies which the best television scanning and reproducing apparatus may require.

As stated above, a 1,000,000-cycle band will accommodate television currents corresponding to about 240-line images. It will also afford channels for about 240 simultaneous high-grade telephone channels. A 2,000,000-cycle system will provide about 480 telephone channels or accommodate television currents corresponding to about 350-line images.

### AT THE TRANSMITTER

Motion picture film was used since it provides a signal which can be repeated over and over again for the purpose of the demonstration. The film moved uniformly past a picture gate where lenses in a large rotating disk swept across it a light beam 3/1,000-inch square. The resulting current contained frequencies between zero and about 800 kc. Before transmission, it was raised by modulation about 100 kc. higher. See Fig. 1.

(NOTE—Sharpness of detail in a picture [or "frame"] implies a rapid change from light to dark, and vice versa. That, in turn, means a current from the photoelectric device that changes rapidly from weak to strong. A changing current can be shown to be a group of alternating currents whose frequencies reach higher values as the change becomes more rapid. Conversely, if the circuit suppresses some of these frequencies the current will seem to change more slowly. That in turn means blurred television details. Hence, a high-quality system is designed to handle high frequencies.)

### AT THE RECEIVER

At the receiving terminal, in a cathode-ray tube, the current was supplied to a set of plates so arranged that the current corresponding to the brightest spot on the film centered the electron stream on an aperture 1/200-inch square. For less bright points, the beam did not center on the aperture and fewer electrons were passed. The stream then passed two more pairs of plates, one of which swept it back and forth 5,760 times a second; the other swept it up and down 24 times a second.

To permit the use of standard sound film in the transmitter, the system was designed to scan 24 "frames" a second. The scanning disk contained 240 lenses and ran at 24 revolutions-per-second, thus scanning 5,760 lines a second. Similarly, the screen at the end of the receiving tube was scanned horizontally by the electron stream at the rate of 5,760 lines a second. That is, 240 lines for each of the 24 frames which were transmitted each second.

The frequency limits of transmission are not inherent in the cable itself, but in whatever terminal or intermediate amplifying equipment may be associated with it. In the New York-Philly demonstration 8 unattended intermediate repeater stations were used. To prevent the finer details (higher frequencies) of the image apparently losing synchronism between scanning disk and cathode beam, due to the lowest frequencies traveling over the cable more slowly, delay equalizers were developed which permit all the component frequencies to arrive at the receiving terminal simultaneously.

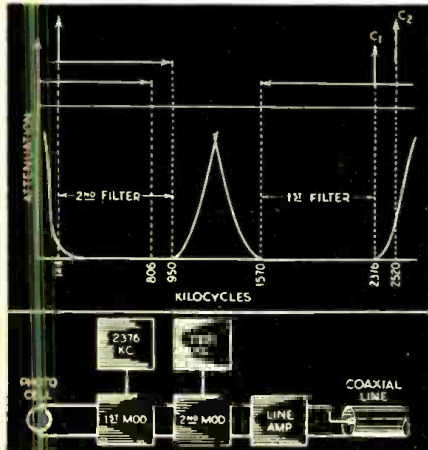

Fig. 1. How the frequency range of the signal was raised 100 kc. higher by double modulation.

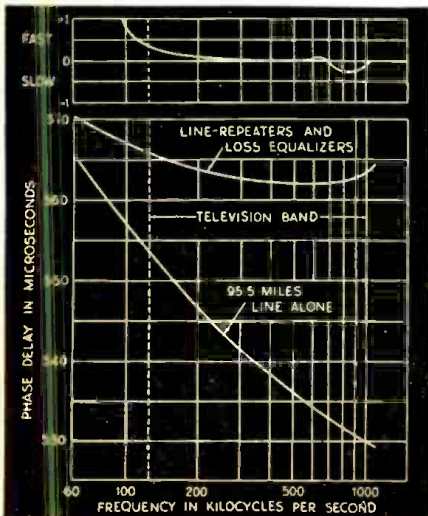

Fig. 2. Phase delay curves of the N.Y.C. to Philadelphia coaxial television circuit.



# SUCCESS STORY!

HE is a serviceman and today he's sitting pretty. He got that way selling service — service you can't beat — WHOLESALE service. It wasn't long ago that he was just another serviceman. Getting by — that's about all. Then he sent for the Wholesale Radio catalog, and things began to happen. For with that catalog he was able to quote prices that left competition out in the cold. He gave delivery dates (and met them) that surprised his customers. He put on one assistant and then another. He became the most sought after man in town. The Wholesale Radio Catalog is FREE! Have you sent for your copy?

Here is a sample of what the Wholesale catalog covers and how you too can profit



**PUBLIC ADDRESS:** fifteen catalog pages devoted to Lafayette P.A. — distinguished, lower-priced sound equipment. Ideas for selling sound, fields undreamed of yesterday. How to make money as a dealer or in spare time selling, renting, installing this fast-moving, world famous LAFAYETTE line.

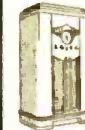

**RADIOS:** the great new line of Lafayette receivers for 1938. Console models that have what it takes to bring out the check books of your "Park Avenue" customers. Powerful little sets beginning as low as \$8.95. Show them these LAFAYETTES.



**PARTS:** test instruments — the greatest assembly of radio parts — pictured, priced and accurately described — that has ever been offered, even by Wholesale. Obsolete replacement or the latest item of the foremost manufacturers. Wholesale has it for you.



**DON'T PUT IT OFF—Mail the coupon now for your copy of this money-making best-seller — the greatest catalog in radio.**

**MAIL COUPON NOW**

**WHOLESALE RADIO SERVICE CO. INC.**  
NEW YORK, N.Y. • CHICAGO, ILL. • ATLANTA, GA.  
100 W. 11TH ST. N.W. • 301 W. JACKSON BLVD. • 400 W. PRAIRIE ST. N.W.  
BOSTON, MASS. • BRONX, N.Y. • NEWARK, N.J. • JAMAICA, L.I.

**WHOLESALE RADIO SERVICE CO., INC.**  
100 SIXTH AVENUE, NEW YORK, N. Y.

Rush FREE 1938 Catalog No. 69-388

Name.....

Address.....

City.....State.....

PASTE COUPON ON PENNY POST CARD

## DEHYDRATED CONTROL-ROOM WINDOWS

For a long time, the glass-paneled control rooms from which radio programs are monitored have been the bane of studio officials, due to the fact that the sound-proof layers of windows became clouded by the moisture existing between them.

In the new WMCA studios this nuisance has been eliminated by a new patented method of observation glass installation. The windows consist of 3 separate layers of varying thicknesses. First there is a half-inch layer, then a three-eighths-inch and finally a quarter-inch strip.

These layers are embedded in sponge rubber so as to vibrate with sound and prevent its escape. Between the layers, the air is dehydrated by a special process which eliminates the moisture and thereby prevents clouding of the layers.

Please Say That You Saw It in RADIO-CRAFT



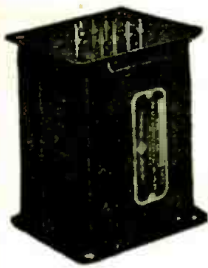

**BE WISE  
and  
KENYONIZE**

Your  
**T20, TZ20 and 809**

With  
**KENYON T-378  
Filament Transformer**

7.5 V. or 6.3 V. 7A C. T. 2000 V Test  
**NET PRICE - \$3.00**

See Your Local Jobber  
or Dealer for Bulletin on

**T-378**

**KENYON TRANSFORMER CO., INC.**

840 BARRY ST. NEW YORK, N. Y.  
Export Dept., 25 Warren St., New York, N. Y.



## TRANSOIL

for transmitting

**HIGHEST QUALITY  
OIL CAPACITORS**

Ask for new complete  
Transmitting Catalog  
describing

TRANSOIL—SOLAREX—TRANSMICA

SOLAR MFG. CORP.  599 BROADWAY  
NEW YORK CITY



**SAVE  
UP TO 50%**  
1938 Models  
Latest Features  
MONEY BACK  
GUARANTEE  
Free Catalog  
Zephyr Radio Co.  
13141 Hamilton  
Blvd.  
Detroit, Michigan

## RADIO ENGINEERING



RCA Institutes offer an intensive course of high standard embracing all phases of Radio. Practical training with modern equipment at New York and Chicago schools. Also specialized courses and Home Study Courses under "No obligation" plan. Catalog Dept. RT-38.

**RCA INSTITUTES, Inc.**

A Radio Corporation of America Service  
75 Varick St., New York 1154 Merchandise Mart, Chicago

## PUSHBUTTON TUNING—REPLACES DIAL TWISTING

(Continued from page 459)

**7** Motor-driven tuning system, described more fully under section 2 above.

**8** Sparton (Selectronne) Pushbutton tuning. A trimmer condenser tuning system. Depressing any button connects a set of 3 pre-aligned trimmer condensers into the tuning circuits of the receiver. Provisions are made for 6 favorite stations; A.F.C. is used.

**9** Motorola, Galvin Manufacturing Corp. A motor-driven pushbutton automatic tuning system. Provisions made for pre-setting and choosing 20 favorite stations. An additional button allows for manual tuning. A.F.C. employed to compensate for off-tuning. The dial indicator (depending upon where it happens to be set) will either move directly to the station chosen or will first travel to either end of the dial, automatically reverse itself, and come back to the chosen point.

**10** Lafayette Pushbutton Tuning. A motor-driven automatic pushbutton tuning system. Provisions for 8 favorite stations. The process of setting up these stations is extremely simple and may be done entirely from the front of the cabinet. No tools being required.

**11** Belmont "Bel-Monitor" Station Selector. This automatic station selector system is entirely mechanical. The bank of selector keys shown in the illustration are linked to an equal number of adjustable centering cams on the tuning condenser shaft. To tune a station, the proper key is depressed. This action simply turns the variable condenser to that portion of the dial on which that station comes in. Conventional knob tuning is always available without the use of changeover switches. The station settings may be easily changed without the use of tools. Adjusting one key does not affect the settings of the remaining keys. Provisions are made for tuning 8 stations on some models and 6 stations on others.

**12** Stewart Warner "Magic Keyboard" Pushbutton Tuning. A motor-driven automatic pushbutton tuning system which makes provisions for 15 stations. As a button is pushed the dial pointer does not "scan" across the dial, but moves by the most direct route to the desired station. A.F.C. compensates for mistuning. Pushing another button releases the preceding one automatically. The stations are pre-set from the front of the radio set without tools.

**13** Trav-ler Radio and Television Corp. A purely mechanical system for rotating the variable condenser to the station desired. After the stations have been set up (easily done from the front of the radio) you merely depress the button of the desired station and swing it around to the bottom of the dial until it can no longer move—there is your station. The precision to which the

stations are tuned depends entirely upon the precision with which the stations were pre-set. Provisions for 8 stations.

**14** Crosley Pushbutton Tuning System. Motor-driven automatic tuning system for 8 favorite stations. The setting up of stations must be done on the chassis in the rear of the receiver and by means of a special key which is provided.

**15** Westinghouse Automatic Tuning. Motor-driven pushbutton tuning system for 13 favorite stations. Manual tuning may be had by pressing a 14th button at the bottom of the dial.

**16** RCA Victor Pushbutton Tuning. Depressing any one of eight buttons starts a motor which turns the variable condenser to the approximate position of the station desired. Automatic frequency control then adjusts the frequency of the oscillator in order to bring the station exactly in tune. Note the huge "cash register" dial which affords excellent band spreading on the short-wave bands. The dial is known as "overseas" dial.

**17** Pacific Radio Corporation "Crusader." A trimmer-condenser tuned system. Each button, with the exception of the center one (which is depressed to obtain manual tuning) switches a pair of trimmer condensers into the tuning circuit. Any one of 6 favorite stations may be thus pre-set for automatic tuning.

All these automatic tuning receivers (with the exception of the one illustrated in photo No. 2) may be tuned manually as well as automatically. In some, a switch must be thrown or an additional button depressed to obtain manual operation. Others may be tuned manually without any switching at all.

It is well to mention here that there are other automatic tuning receivers which are not of the pushbutton variety. In this classification are Stromberg-Carlson, Philco, Fairbanks-Morse, Wilcox-Gay, and others. Some of these are tuned by means of a dial system similar to that of the dial telephone. Each hole in the dial is pre-set and marked for one of the most popular stations. It is then merely necessary to twirl the dial around to the stop position and, presto!—there's your station. Others, taking advantage of automatic frequency control merely use a non-vernier or low-ratio tuning dial to swing the dial pointer around rapidly to the approximate position of a desired station. (Tabs with station call letters, supplied by the manufacturer, are placed around the periphery of the dial [by the consumer] at their respective dial settings.) A.F.C. then automatically adjusts the frequency of the oscillator to bring the station exactly to resonance. The Stromberg-Carlson job uses a rotary selector switch for instantaneous selection of any one of 7 pre-set stations.

## NEW CIRCUITS IN MODERN RADIO RECEIVERS

(Continued from page 471)

(4) DIRECT-COUPLED AMPLIFIED A.V.C.

Motorola Models 12Y and 12Y-1. A very unusual and inexpensive method of attaining amplified A.V.C. as used by Galvin Mfg. Corp. is shown in Fig. 1D. The upper diode plate is biased with respect to ground at 3.5 volts negative, while the cathode is some 60 volts positive due to plate current flow. The lower diode plate, however, is not biased except by incidental grid leakage ( $\frac{1}{2}$ - to  $\frac{1}{2}$ -volt). Rectification starts with the lower diode plate when the signal reaches this peak value. The rectified output is fed to the control-grid as a negative bias and as this advances, the plate current is reduced very rapidly. Only a few volts on the control-grid will reduce the plate current and cathode voltage materially. Until the signal peak becomes high enough to start rectification by the upper diode the A.V.C. is inoperative. The signal peak being practically the same on both diodes, the falling cathode voltage meets the rising signal peak, starting A.V.C. action with the upper diode plate. Any signal in excess of this "crossing point" will produce the conventional A.V.C. voltage, overcoming and increasing the fixed 3.5 volt bias in the controlled tubes.

(5) NEW REACTANCE DIMMER CIRCUIT  
Midwest Model 18-37. Isolating the reactance dimmer from the plate circuits of the A.V.C. controlled tubes permits a flexible, easily adapted circuit. No caution need be taken to balance

or filter out the induced voltages, because the reactance dimmer is not in any way connected to the signal circuit.

As the circuit Fig. 1E indicates, the primary of the transformer is in series with the pilot light and its voltage supply while the secondary is shunted by the plate circuit of a 6C5 triode. The secondary, of course, is the larger winding with many turns of small wire, while the primary is a relatively short winding.

Now the primary will draw current and light the lamp according to the load on the secondary, or current drawn through the secondary. When the triode grid is at zero potential, as for no incoming signal, the current drawn by the tube is maximum and hence the primary current is maximum. A signal will bias the control-grid negative due to conventional A.V.C. action tending to reduce or cut-off the current of the triode. Consequently the primary will draw very little current and the pilot light will become quite dim.

The circuit is used as a tuning indicator, instead of the electric eye, meter, or neon method.

### Hot Diggity!

What a magazine! . . . the March JUBILEE SOUVENIR NUMBER! . . . twice the number of pages . . . covering 50 years of Radio. Reserve your copy now!

Please Say That You Saw It in RADIO-CRAFT



## A NEW V.-T. VOLTMETER

(Continued from page 483)

one having 20,000 ohms/volt sensitivity, we might get a reading of some sort, but one which is far from accurate. The reasons for this are two-fold.

First, since the current which flows in the resistor is extremely small, the current drain of the meter upsets the voltage drop across this resistor.

Secondly, if we were to take the case of a 1.0-meg. load resistor (which is the usual value employed) in an A.V.C. circuit, and attempt to measure the voltage across it with a voltmeter of 20,000 ohms/volt set at, for example, the 25-V. scale, we really shunt a 0.5-megohm resistance (20,000 x 25) across the 1-meg. load resistor. The load resistance value is thus changed to a value one-third of the original—with a consequent change in the amount of A.V.C. voltage which is developed. Actually, what happens with a voltmeter having 20,000 ohms/volt sensitivity, is far more seriously encountered with voltmeters having a lower sensitivity. And, what is true of automatic volume control circuits is also true in automatic frequency control, volume expander, noise suppressor and other trigger-action circuits.

### "NO-CURRENT" OR "V.-T." VOLTMETER

The answer to this problem, then, is a "no-current" draw, or negligible-current-drain type of instrument, typified by the vacuum-tube (or "V.-T.") voltmeter.

This instrument employs a tube with a current-indicating meter in the plate circuit. The grid bias is then adjusted so that none or very little current passes through the meter, with provision for a "reverse" current to permit cancelling out any remaining or idling current and thus insuring a true zero reading.

Since the grid of this tube draws none or negligible current, by connecting potentials in reverse order to the grid of the tube, the plate-current cancelling effect of the bias is overcome and plate current flows once more through the meter. The meter is then calibrated, so that various potentials applied to the grid produce corresponding plate current readings of the meter. As a rule, the construction and calibration of an efficient V.-T. voltmeter is quite a problem.

### A SERVICING-TYPE V.-T. VOLTMETER

A very successful unit with several features for servicing demands is that shown in Fig. A. It is exceedingly stable in operation; is well calibrated; operates from either 110 V. A.C. or D.C.; and measures both A.C. and D.C. potentials. The wiring diagram is shown in Fig. 1, and, as will be noted, 3 tubes are employed.

The first tube, a 6C6, is used as a "condenser-diode rectifier", for rectification of any A.C. potentials to be measured. The second tube, a 76, is the V.-T. meter stage; and the third tube, another 76, serves as the power rectifier tube operating from either a 110-V. A.C. or D.C. line. The sensitivity of the unit may be controlled by the "reverse-current" controlling resistor (which serves to deflect the indicator beyond

zero), the more reverse current applied the greater the sensitivity.

### NOVEL VOLTAGE DIVIDER

Attention is called to the novel voltage divider arrangement employed across the A.C. and D.C. voltage input terminals. This divider consists of a series connection of very high resistances which enable several ranges of A.C. and D.C. potentials to be measured by the voltmeter stage.

The conventional method is to employ an arrangement of resistors in the plate circuit of the tube to permit changing the amount of plate voltage, thus reducing or increasing the sensitivity of the tube to various ranges of applied potentials.

In this new method, instead, the input resistance is fixed regardless of what voltage or circuit the meter is applied to. In the instrument referred-to, the input resistance is increased as the voltage range is increased (the applied voltage to the V.-T. tube is constant), and consequently, the instrument load is more uniform.

The ranges thus obtained are 0-5, 15, and 150 V. on A.C., and 0-6, 20, and 60 V. on D.C. For conventional D.C. measurements, no special pains are necessary, though the leads should not be too long or close together when checking D.C. voltages across R.F. circuits. For A.C. measurements, precautions necessary will vary with the frequency being measured. For frequencies above 400 cycles, a low-capacity shielded cable (such as employed for shielded antenna lead-in connections to a car-radio set) should be employed, or else the ordinary leads should be kept as short and as far apart as possible.

Concerning the various applications of a V.-T. voltmeter, the writer has too little space available to go into its multitude of uses. Besides, up-to-date data has been given in recent issues of *Radio-Craft*. (See the March, April and June 1937 issues of *Radio-Craft*.)

This article has been prepared from data supplied by courtesy of Superior Instruments Co.

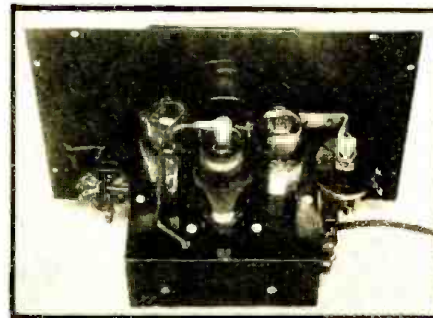

Rear view of the V.-T. Voltmeter Chassis showing the locations of tubes and parts.

## HOW TO MAKE A SIMPLE 4-TUBE REGENERATIVE A.C.-D.C. SUPERHET.

(Continued from page 472)

- One Solar mica condenser, 400 mmf.;
- One Solar mica condenser, 250 mmf.;
- One Solar mica condenser, 100 mmf.;
- One Centralab volume control with switch, 10,000 ohms;
- One Cornell-Dubilier electrolytic condenser, 25 mf., 50 V.;
- Seven Cornell-Dubilier paper condensers, 0.05-mf.;
- One Cornell-Dubilier paper condenser, 0.001-mf.;
- One Cornell-Dubilier paper condenser, 0.006-mf.;
- \*One dynamic speaker with output transformer, 4,000-ohm field, ch.1;
- One Cornell-Dubilier electrolytic condenser, 175-V. type, 8-30 mf.;
- Five octal sockets;
- One Stancor filter choke coil, 450 ohms, ch.2;
- One Raytheon K-49-C ballast tube;
- One Raytheon type 6A8 tube;
- One Raytheon type 6J7 tube;
- One Raytheon type 25L6 tube;

- One Raytheon type 25Z6;
- \*One line cord and plug;
- One homemade chassis;
- \*One airplane dial;
- \*Two knobs;
- One Continental Carbon resistor, 500 ohms, 1/2-W.;
- One Continental Carbon resistor, 50,000 ohms, 1/2-W.;
- One Continental Carbon resistor, 30,000 ohms, 1/2-W.;
- One Continental Carbon resistor, 10,000 ohms, 1/2-W.;
- Three Continental Carbon resistors, 0.5-meg., 1/2-W.;
- One Continental Carbon resistor, 0.2-meg., 1/2-W.;
- One Continental Carbon resistor, 0.5-meg., 1 W.;
- One Continental Carbon resistor, 2 megs., 1/2-W.;
- Hook-up wire, hardware, etc.

\*Most Radio mail order houses can supply this item if properly identified as to title of article, issue (month) of *Radio-Craft* and year.

Please Say That You Saw It in RADIO-CRAFT

**THE**  
*Standout value*  
**FOR '38**

**The WESTON**  
**Model 772**  
**Super-Sensitive**  
**Analyzer**

- ★ Simplified, easy-reading scale, AC readings on single AC arc
- ★ Decibel readings for sound measurement
- ★ Current ranges for auto testing
- ★ New, improved rectifier circuit... accuracy (WESTON guaranteed) 3% on normal frequencies
- ★ Temperature error (WESTON guaranteed) within 2° from 40°F to 110°F
- ★ 20,000 ohms-per-volt... big, dependable, 50 microampere WESTON Meter
- ★ Broad ranges to meet every requirement testing receivers, transmitters, television, vacuum tube and cathode ray equipment, sensitive relay circuits, etc.
- ★ Sound engineering... expert craftsmanship... highest quality parts... dependability for years

Resolve, now, to start the year right with dependable test equipment... equipment that remains dependable and stays serviceable throughout the years. When you buy an analyzer, for example, be sure it's the WESTON 772, for no other analyzer has a proved WESTON Meter... resistors of equal precision and stability... perfected WESTON silver contact switches, and other materials and parts of WESTON's high quality standards. Start the year right... end it with more profit... with WESTON test equipment. Send coupon for complete information.

**WESTON**  
*Instruments*

---

Weston Electrical Instrument Corporation  
599 Frelinchysen Avenue, Newark, N. J.  
Send complete information on WESTON Radio Instruments.

NAME \_\_\_\_\_  
ADDRESS \_\_\_\_\_  
CITY \_\_\_\_\_ STATE \_\_\_\_\_



# THEY'RE all in the New FREE 1938 Catalog

Standard Make Radio Sets

MODELL'S catalog of Standard sets has created a sensation in the radio world. This marvelous 44 page book lists over 400 different makes and models of home electric sets, from battery sets and auto radios, made by the leading nationally advertised manufacturers, such as RCA—Philco—G. E.—Zenith—Motorola—Delco—Grunow—Crosley—Strömberg—Carlson—Kadette—Emerson—Fada—Garol—Halsom and others. If you are interested in radios, get this Encyclopedia on Standard Radio Sets and details how you can make money in your spare or full time. DO IT TODAY.

Mail coupon to address nearest you.



## Modells'

Since 1889  
Dept. D-9,  
58 Cortlandt St.,  
New York, N. Y.  
56 W. Washington St.,  
Chicago, Ill.  
57 Forsyth St.,  
Atlanta, Ga.

MODELL'S, Dept. D-9,  
58 Cortlandt St., New York City, N. Y.

- Send me Your 44-page 1938 catalog
- How may I increase my income

NAME .....

ADDRESS .....

CITY ..... STATE .....

Paste coupon on penny postcard

Send for your copy TODAY



## Do You Like RADIO

TELEVISION, SOUND & ELECTRICITY

You men who want to know the true facts about employment opportunities and requirements in radio and related industries should have Nannon's new book—40 pages of information and illustrations.

NATIONAL SCHOOLS

Dept. RC-2, 4000 So. Figueroa Street, Los Angeles, Calif.  
Please Send Free Book

NAME ..... AGE .....

ADDRESS .....

CITY ..... STATE .....

"DEPEND ON DEPENDABLE"

DON'T BUY TEST EQUIPMENT

until you've investigated Radio City products. See your jobber. Write to Dept. C for catalog.



Better - Quicker - More Profitable Servicing with RADIO CHASSIS CRADLE



Service shops need the RADIO GIMBLE (chassis cradle) for efficient servicing of testing and repairing of receivers or amplifiers. Equipment clamps to cradle which can be adjusted to any angle. Accommodates chassis up to 13 x 12 x 23 inches. Excellent for displaying receivers. Write for illustrated circular RCI

WM. A. THOMAS CO. 321 CAROLINE ST., NEENAH, WISCONSIN

Increase the Respect and Confidence of your customers by rejuvenating their old radio with a Wright-DeCoster Speaker.

Write for literature and name of nearest distributor.

WRIGHT-DE COSTER, INC.,  
2251 University Ave., St. Paul, Minn.

## SERVICING Q. & A.

(Continued from page 481)

minimum-capacity setting so that the oscillator will track 456 kc. above frequency of tuned signal. There are usually 2 settings of the oscillator high-frequency trimmer. The one of minimum capacity is correct.

### OSCILLATION

(41) Abe Engle, Riverdale, N. Y.  
(Q.) I have an A.C.-D.C. American Bosh 501 receiver which whistles. Have checked voltages and replaced most condensers. Can you inform me as to what the trouble is?

(A.) A whistling condition in the receiver mentioned in your inquiry may be due to any one of several causes. You do not state whether the whistle or oscillation is present over the entire broadcast band, when tuning any station to resonance, or only upon certain stations.

Oscillation over the entire band in these receivers is generally due to a loss in capacity of either or both filter condensers. Try shunting a 0.1-mf. 400-V. paper condenser across the second filter, should you find that replacement of either or both filter condensers fails to relieve the difficulty.

A whistle heard when tuning any station to resonance may be due to an aerial that is much too long. A whistle only upon certain stations at the low-frequency end of the broadcast band most likely is image-frequency interference and may be corrected by shifting the intermediate frequency to a higher frequency. This necessitates the use of a signal generator and recalibration of the dial by adjustment of oscillator trimmers.

### CHANGING POSITION OF VOLUME CONTROL

(42) C. A. Anderson, Harrow, Ont., Canada.  
(Q.) I have difficulty with a Zenith Radio model 91-92. The A.V.C. system does not work very steadily and is distorted. Could you give me the value of the volume control which, in the first series of this radio line, was in the A.V.C. circuit?; the second series used the volume control in the audio circuit. Please tell me the value of the resistor used to replace the volume control in the A.V.C. when it is moved to the audio circuit.

(A.) The value of the volume control for the early Zenith model 91-92 is 4,500 ohms, and is used in the cathode circuit of the A.V.C. 24 tube. The control for audio regulation in the second series of this model is 250,000 ohms and is connected as shown in Fig. Q42. In replacing the former system with the latter type use a resistor that is variable from approximately zero to 4,000 ohms and at least a 20-W. unit for current dissipation.

### VIBRATOR HASH

(43) Herman E. Piame, Fonda, N. Y.  
(Q.) I am writing about a United Motors radio set. 32-V. D.C. model 4049. This set has excessive vibrator noise which can be tuned in from 540 to 800 kc. It is more noticeable during the day. I tried another vibrator but the noise was the same. Poor volume during the day is experienced during the day from 540 to 860 kc. New tubes did not help. Will you please help me in this problem?

(A.) The noise pick-up on the United Motors 32 V. D.C. receiver, model 4049, heard principally from 540 to 800 kc. may be reduced or eliminated by following one or all of the following methods.

It is essential that the vibrator case be securely grounded to the receiver and a good ground connection made to the receiver. Replace the input filter condenser of the "B" supply. Check and/or replace the vibrator buffer condenser. Use only an exact replacement for the buffer condenser if found necessary.

Erect a good long antenna as far as possible from the voltage supply for the receiver. Should these suggestions fail, realign the receiver completely, adjusting the padder carefully.

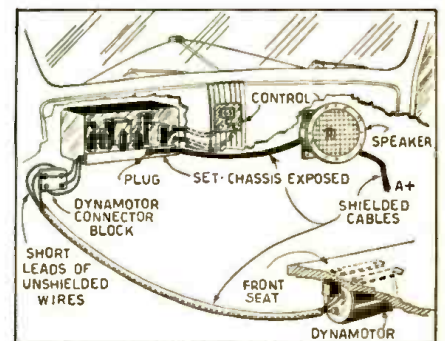

Fig. Q39A. Cables on A.K. 756 must be shielded.

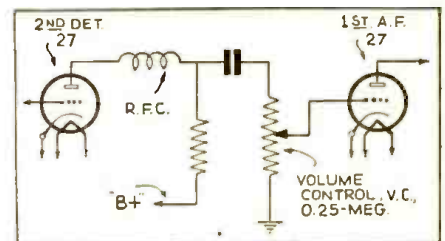

Fig. Q42. Location of defective volume control.

## NEW RADIO ITEMS FOR CAR OWNERS

(Continued from page 482)

shaft. Increasing the tension raises the speed at which the contacts will close and reducing the tension lowers it.

To test for proper operation tune the receiver to a local station and adjust the volume to an output of approximately 1 watt. When the paddle on the air switch is swung back against its stop the volume should be increased to 1.4 times the original output. If there is no change in volume disconnect the lead from the air switch and ground to the cylinder head. If grounding this lead increases the volume, check the contact points in the switch to see that they are not sticking or dirty. If grounding this lead does not change the volume check the lead where it enters the receiver for open or loose connection.

Diffusion-Louver Car-Radio Set. In place of the usual cloth or metal screen over the loudspeaker, the new Firestone auto-radio sets for 1938 utilize louvers or vanes that slant downward, as shown in Fig. D. We hereby christen this set "the driver's friend," for it is kind to the driver; the louvers tend to direct the sounds from the loudspeaker toward the rear of the car, instead of nearly blasting the driver out of his seat, when the volume is brought up to

meet back-seat listening requirements. Trailer and Home Dual-Wave Radio Set. Radio sets for the trailer have undergone changes to meet the specific needs of this type of service. Newest in this line is the radio set shown in Fig. E. It operates on either 6 V. D.C. (storage battery, ordinarily), or on 110 V. A.C. (lighting current—at home or in trailer camp). Other points of interest: 2 wavebands—200 to 545 meters, and 54.5 to 16.5 meters; set may be used with privacy plug in, secret volume governor, and remote loudspeaker. This set is made by Zenith.

Long-Wave Converter for Car-Radio Sets. If it's Government weather reports, lake and coast-wise ship signals, or beacon and airplane signals you want to hear on your car-radio set, here's a converter you connect to the antenna and ground posts of your car-radio set, to do the trick. This instrument was mentioned in *Radio-Craft* last month; it is reproduced here, together with its schematic circuit, as a matter of completeness; the circuit, which was not shown last month, is given in Fig. 1 (the unit appears, pictorially, to the right of it). Tuning range is 130 to 430 kc. (2,307 to 697 meters). Converter is made by ABC Radio Laboratories.

Please Say That You Saw It in RADIO-CRAFT



## IS RADIO SERVICING MERELY A STEPPING STONE TO HIGHER POSITIONS IN THE INDUSTRY?

(Continued from page 486)

radio servicing. However a man can't break into the radio service field. The most difficult task possible is to learn how to learn the art of radio servicing. Everything mentioned in this article is correct but the hardest thing for any man wanting to learn radio is how, where, and when I got through have I found out what I want.

Our means of radio education has so many evils that it is extremely difficult to advise a man the correct way to learn radio. I feel confident I have the solution to most of these problems and some day some one will put them into practice. However that is not answering the question before us.

Mr. Kennedy states, "Radio servicing is not a goal but a stepping-stone . . ." My opinion is radio servicing is a testing laboratory. A person interested in radio, tries the radio service game. Here he learns a lot. He finds out many things; a few are listed below:

- (a) Whether or not he likes radio;
- (b) Whether or not he has what it takes, education, experience, adaptability, personality, and hundreds of essentials not found in books, magazines, or correspondence courses or schools;
- (c) The man with intestinal fortitude and ambition continues, the others drop out;
- (d) If he likes radio and expects to make it a vocation, it affords him the opportunity of learning just what it is in radio he likes best and wants to pursue. It may be, and often is, superior radio service.

Most of the big men in radio were at one time or another radio Service Men; however they were also a lot of hams, or fellows interested in amateur radio at the top. Both of these methods seem to be the starting point of kindergarten of radio promotion. Yet a great many hams and radio Service Men never reach the 1st Grade in radio.

It is absolutely true that you must like radio to be able to find it a pleasure; you must like any type of work to succeed, but there is more to the game than liking radio to be a success. Liking radio is essential yet only one factor. It takes a lot more than liking a certain thing to succeed in it.

Experiment. Radio service work is an experimental laboratory. Unfortunately an extremely large percentage of the radio Service Men experiment, find some very startling answers yet are unable to analyze this experiment for their own benefit. Hundreds of inventions have been patented but perhaps the man performing the experiment revealing this invention did not get the patent. Why? He made the experiment, wrote it down, and then didn't realize what he had found, simply got the results without understanding their meaning, someone else got hold of the notes on the experiment and saw what actually was found. The man who experimented with soda drinks and found Coca Cola had to be told to BOTTLE IT, before it was popular.

Radio service brings you close to people, you find out their secrets, the way to get along, etc., but unless you use them to your own advantage this means nothing. Maybe the thrill in radio is selling, designing or building, but unless radio service points this out to you and you learn to grasp it, all is lost.

"Let radio service lead you to this goal," states Kennedy, then gives a lot of 1F's, and certain conditions one must have or be able to acquire. Exceedingly interesting, but exceptionally difficult to obtain.

My interpretation of "Is Radio Your Vocation?" is a picture of the few successful radio Service Men. It is like a painting of the bloom of a beautiful rose without showing the stem and all the thorns. To one already in the radio service business, it shows what we most desire, what we all hope for, and few ever get. To the radio man who is about to start in the radio service business it is a picture of encouragement, instilling enthusiasm and ambition but a wrong conception of the most probable outcome.

If all the money I needed was at my command, it would not be spent for pleasure, on myself or family, or to encourage young men to take up radio, rather it would be spent to develop the educational system making the dreams of this article come true. The present-day Service Men dream of these things, but at present there is

no system of education complete enough to give all the essentials in making these dreams come true. Only the men that have exceedingly broad minds, are ambitious, well read, with proper technical training and opportunity to get the required experience and outside advice on this experience, are fitted to accomplish the goal set forth in "Is Radio Your Vocation?"

My suggestion is let's have less theorizing, or day dreaming and unite in a plan to accomplish our goals in radio.

ROGER H. HERTEL,  
c/o Radio Service Dept.,  
Anderson Electric Co.,  
Wahoo, Nebraska.

### AWARD

Editor, RADIO-CRAFT:  
My personal opinions toward "Radio as a Vocation":

I firmly believe many things that Mr. Kennedy said; it is very true that most Service Men live mostly on their wit. As a true reader of *Radio-Craft* I come from Decatur, Ill., and am only visiting here in Wellington. In Decatur, a population of 60,000, only 3 out of 25 to 30 Service Men make a decent living or a wage of \$25 a week.

The others live on their imagination; even those with a business hardly get along. I know of one house that services an average of 200 sets a month, won't pay their men but \$12 a week, and after you have worked there for more than 2 years they might pay you \$16 to \$18, but on top of that you still must furnish your own tools and equipment. What do you think of that?

I might say further that in some larger city you might get more, but oh! your living expenses.

I also firmly believe that radio service is a very good stepping-stone to other fields such as dealer, designer, chief engineers, etc., and by some other ability they march forward to greater success.

I also think you must like your work, in this way you are willing to put in many hours in study, research and also in experimentation; in this way we learn many things that we wouldn't know otherwise. You have to like a certain thing before we can make a success of it.

It is very true that servicing brings us face-to-face with all problems of life; also the ways of the people. In order to sell well, you must know your customer, his ways, quality of merchandise that he wants, and also his attitude. The best salesman is the one who can place his customer the minute he steps into the store.

(But after all no matter how good you are at anything it just seems like you have to have a pull to get there.)

After all, in my experience, most all dealers I have spoken to and whose business I have looked over, radio is just a sideline to over 80 per cent of the dealers.

They place radio together with electrical, refrigerator, keys, bicycles, and many other forms.

We all hope; no matter how we work it out, our aim is to make a living.

KENNETH BARR,  
Decatur, Ill. (Wellington, Tex.)

### AWARD

Editor, RADIO-CRAFT:

I can very easily agree with Mr. Kennedy's statements in the November issue of *Radio-Craft*. About 4 years ago I was a radio Service Man with a small place of business in New York City. I had gone to Evening School for 2 years and studied radio repairing. Upon graduation I had borrowed some \$300 and opened a radio retail store. Somehow things didn't work out as I planned and all my hopes and ambitions were shattered.

Somehow all was not dark for me. I took a Civil Service position with the U. S. Government as a clerk and for 4 years I worked as a public servant. Radio and radio servicing were far from my mind. I felt that it was a field that was overcrowded, a field that could never amount to much.

But the old blood boiled in me. I had that  
(Continued on following page)

## RACO CRASHES THROUGH WITH NEW S-W VALUES

You fans who want real DX must have a RACO SHORT-WAVE RECEIVER. Any one of the many RACO sets pulls in stations from far corners of the globe.

### UNIVERSAL CLIPPER



Uses the new 251A low voltage beam power tube which makes possible high power output with an inexpensive A.C.-D.C. power supply, operating from any type of 110 volt current. Here is the famous CLIPPER circuit. The same smooth, non-critical tuning; combined regeneration and super-regeneration; separate bandspread and ultra-high frequency tuning condenser; 5 inch dynamic speaker; 3 to 555 meter tuning range; automatic earphone jack; in fact, all of the splendid features which make the CLIPPER circuit a tremendous success.

ASK THE MAN WHO OWNS A CLIPPER—LOOK AT HIS LOG!

COMPLETE KIT WITH ALL PARTS ASSEMBLED and wiring diagram; less only tubes and cabinet, un-wired . . . \$12.40

Black crackle finish cabinet . . . . . 1.80  
Matched set of five tubes . . . . . 3.20  
Wiring . . . . . 2.90

UNIVERSAL CLIPPER—COMPLETE, with black crackle cabinet (20" x 10" x 9"); five tubes; 6KT, 2-6J6, 251A, 2526G; ready to operate, and one-year guarantee. . . . . \$19.50  
Special Complete Price

### THE NEW RANGER

3-TUBE UNIVERSAL A.C.-D.C.



AMAZING VALUE IN THIS SPLEN-

DID ALL-WAVE SET! You will be astounded at the way it brings foreigners rolling in. Yes, and separates them, too! Uses supersensitive electron coupled regenerative circuit giving smooth tuning and perfect regeneration control over its entire wave-length range. Tunes from 15 to 550 meters with positively no skips.

RANGER 3-TUBE UNIVERSAL A.C.-D.C.—complete kit, assembled but not wired, including wiring diagram and broadcast coil but less cabinet and tubes 3 additional coils (15 to 200 meters) . . . . . \$4.50

Crystallized metal cabinet . . . . . .90  
Set of three tubes (2-6J6G: 1-6A7) . . . . . 1.35  
Wired and tested . . . . . 1.40  
SPECIAL COMPLETE PRICE with all coils, cabinet and tubes, wired and tested, with one-year guarantee . . . . . 8.25

## FREE Catalog!

Kits, receivers, converters, valuable antenna information—everything you'd expect to find in a complete short-wave catalog—at prices astoundingly low. Write today for RACO'S LATEST SHORT-WAVE CATALOG—illustrating and technically describing RACO'S complete line of long distance receivers.  
ADDRESS DEPT. RC-238

RADIO CONSTRUCTORS LABORATORIES  
136 LIBERTY ST., NEW YORK, N. Y.

• WITH RACO SHORT-WAVE KITS YOU CAN ALWAYS BUILD BETTER RECEIVERS •



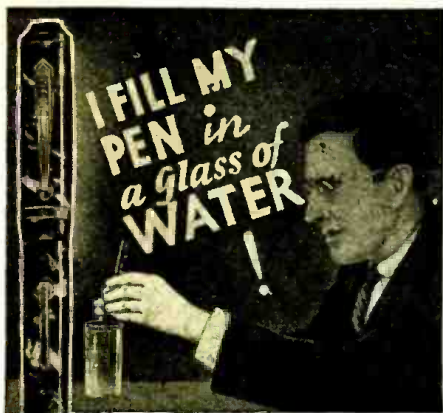

**... Men!  
HERE IS THE  
MODERN MIRACLE  
WATER PEN —**

WHEREVER there's water, there's ink—for the MIRACLE WATER PEN. There's a tiny ink cartridge in the barrel of the pen—two or three lifts of the suction lever and the pen is completely filled. One small ink cartridge keeps this modern pen supplied with ink for many months.

All parts of MIRACLE WATER PEN are acid "corrosion" proof. Nibs are 14-karat gold-plated. Airtight inner cap keeps pen moist at all times. The ordinary fluid capacity is almost twice other pens. Five additional ink cartridges are carefully hidden in a reserve chamber. MIRACLE WATER PENS carry a life-time guarantee.

Order your MIRACLE WATER PEN today — by mail. Sent POSTPAID anywhere upon receipt of check, money order or cash for \$1.50. Regular \$4.00 value.



**GRENPARK COMPANY**  
1229 Park Row Bldg., New York, N. Y.

GREN PARK COMPANY RC-238  
1229 Park Row Bldg., New York, N. Y.  
Gentlemen: Enclosed you will find my remittance of \$..... for which send me..... MIRACLE WATER PENS at one dollar and fifty cents (\$1.50) each. YOU ARE TO SEND ME THE PEN POSTAGE PREPAID. (In U.S.A. only.)

Name .....

Address .....

City ..... State .....

(Send remittance by check, money order, unused U. S. Postage Stamps. Register letter if you send cash with order.)

(Continued from preceding page)

inventive and mechanical lust in me. I couldn't very readily work as a clerk when I knew I longed to continue in radio. So I enrolled as a student in the National Radio Institute. I feel that with the added knowledge and training I will obtain, and the little experience I've already had as a Service Man I can again be doing radio servicing.

But, and it is a big "but," I will never be a Service Man before I am sure I can succeed as one. In other words I won't stop with service work. I am going to specialize in aircraft radio design and feel that then and only then will I really reach my goal. I am quite sure that many radio Service Men are paupers who never will amount to more than the average man with only a modest living wage. I've seen it and I know. I've been in that condition myself which certainly ought to prove my statements twofold.

HARRY RINGEL,  
Washington, D. C.

**HONORABLE MENTION**

Editor, RADIO-CRAFT:

In response to the article "Is Radio Your Vocation?" in the November issue of *Radio-Craft*:

I believe that the training and actual experience acquired by a good Service Man would be a valuable asset and stepping-stone to a position much higher (in salary at least) in the radio industry. However, I do not think that the fact that he was thoroughly trained, and had several years of experience to his credit, would be sufficient to qualify him for an executive position at a large salary. I think that in addition to the practical knowledge, the executive must have a more or less natural tendency toward leadership and have business ability to be successful as an executive.

I believe also that there is an unlimited opportunity, in the field of service, for a man well-trained in that branch of the industry to reach a goal worthy of anyone's ambition. As things are today, too much emphasis is placed on "speed and production" and the Service Man whose policy is to do the very best work possible, even though his prices are at first considered rather high, will eventually win out and find himself with a thriving business of his own which properly handled should net him as good a living (all things considered) as any executive or managerial position could possibly do.

ALBERT F. HARRIMAN,  
Erving, Mass.

**HONORABLE MENTION**

Editor, RADIO-CRAFT:

In answer to Mr. J. P. Kennedy's article in the November issue of *Radio-Craft*, I find that while I agree to part of what he says I also must disagree with him. True that some of our greatest engineers and manufacturers were once Service Men. But what of it! One cannot start from the top of the ladder. Servicing in my opinion is the best way to start out because one learns many interesting things repairing sets. He learns the many peculiarities which can make a radio stop playing, things which are so simple and yet can keep one in the dark for a long time until discovered. Mainly one finds out the many Service Men in the field who cannot do a job right because of not enough experience and intelligence of the subject as a whole.

I agree that one must like radio to select it as a vocation and because of this should advance from a simple Service Man into a larger field in radio.

However, I think radio service is at least one of the vocations that will not be crowded for a while yet. That is where I disagree with Mr. Kennedy. There is always room for a good Service Man. I have had many complaints about jobs being done improperly but I believe that these men will sooner or later be forced out by themselves because of this inability to compete with a Service Man who has thorough knowledge on the subject. Many men are only doing this as means of scraping a few more pennies either down in a basement or in a garage but how long can they last? Magazines such as *Radio-Craft*, and newspaper articles, have recently been opening the eyes of the public to these incapable men and *gyps*, and people will not patronize

Ask the Radio Man  
Where He "Learned"  
the "What's What"  
About Test Equip-  
ment, Tubes, P. A.,  
Home Recording and  
other Radio Subjects  
THE ANSWER—  
The RADIO-CRAFT  
LIBRARY SERIES

The RADIO-CRAFT LIBRARY SERIES has been the foundation for instruction for thousands in radio—in one or more of its specialized branches. For P.A. there's a book—for Auto Radio Servicing there's another—for Home Recording there's also a valuable text—for Theory of Vacuum Tubes—for Specialized Diagrams—for Servicing Various Receivers—for Test Equipment—and other subjects—each has a special volume.

Radio's most noted writers—Clifford E. Denton, Louis Martin, Robert Hertzberg, R. D. Washburne, Joseph T. Bernsley and others are the authors of books in the LIBRARY SERIES.

Each book contains 64 pages—measures 6 x 9 inches. The number of illustrations in the books vary from 50 to 120. Each volume sturdily bound with flexible cover. BOOKS ARE UNIFORM.

**Here are the titles:**

2. MODERN VACUUM TUBES.
3. THE SUPERHETERODYNE BOOK.
5. HOW TO BECOME A SERVICE MAN.
6. BRINGING ELECTRIC SETS UP TO DATE.
8. RADIO QUESTIONS AND ANSWERS.
9. AUTOMOBILE RADIO AND SERVICING.
10. HOME RECORDING AND ALL ABOUT IT.
12. PUBLIC ADDRESS INSTALLATION AND SERVICE.
13. ABC OF AIR CONDITIONING.
14. POCKET RADIO GUIDE.
15. ABC OF REFRIGERATION.
17. SERVICING WITH SET ANALYZERS.

To order any one or more of the volumes in the 50c RADIO-CRAFT Library Series—clip—fill—and mail coupon below, with remittance, to RADICRAFT PUBLICATIONS, Inc., 99 Hudson Street, New York, N. Y.

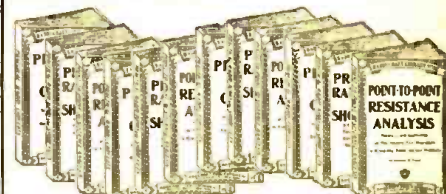

**MAIL COUPON TODAY!**

RADICRAFT PUBLICATIONS, INC. RC-238  
99 Hudson St., New York, N. Y.  
Gentlemen: I have circled below the numbers corresponding to the titles in the RADIO-CRAFT Library Series. My remittance for the amount of \$..... is enclosed.

2 3 5 6 8 9 10 12 13 14 15 17

Name .....

Address .....

City ..... State .....

Books sent PREPAID In U.S.A. only.

Please Say That You Saw It in RADIO-CRAFT



then so easily as was done before. So instead of discouraging men who wish to learn radio service I am for encouraging them as long as they like it and are willing to give the public full benefit of their knowledge.

S. DIGIACOMO,  
New York, N. Y.

**HONORABLE MENTION**

Dear Sir:

Yes, I quite agree with Mr. Kennedy when he says that radio service work is just a stepping-stone to better radio positions.

I know this from my own experience as well as that of several friends. I am a Service Man in a small town, being the only one in the business. I do this work in my spare time as I have

not as yet found it possible to make enough money to warrant giving up a permanent position. This of course is due mostly to the constant study and up-to-date equipment that is necessary.

Two of my very personal friends started in the service field just the same as I have. They have now each obtained good positions with two of the larger radio manufacturing companies, due to what they learned while doing service work.

There will never be any more for any Service Man until the field has been cleaned of the "gypps" and "chiselers" in the game. This, and a standard price scale, will make service work both pleasant and profitable for the honest and efficient Service Man.

Very truly yours,  
MALCOLM COFFIN,  
Groveland, Mass.

**THE RADIO MONTH IN REVIEW**

(Continued from page 455)

by a concentric transmission line through goniometer and line-branching unit, splitting power equally to each tower tuning unit. Each 21-ton tower rests on 100 tons of concrete over piles, and is hurricane-proof. The station is marked for aviators, lying centrally among 5 New York airports, notwithstanding open-area location.

First award of the Armstrong medal of the Radio Club of America was made to Dr. Louis A. Hazeltine, neodyne inventor, at the club's annual dinner last month.

**RADIO'S TIMELY PROBLEMS**

**E**XPLAINING why U. S. manufacturers cannot sell radios in Australia, the American Department of State told the R.M.A. last month that the Australian Government owns 51% of stock in radio factories down under. The reply of the Australians has not arrived.

Federal Trade Commission cracked down last month on "5-tube performance" as a slogan for sets without 5 tubes. If used, it must be preceded by "4 tubes" or what it has.

Philo, of Philly, announced production of its 10,000,000th set last month. This was presented to shut-in veterans at Walter Reed Hospital, Washington, on Armistice Day, while duplicates were given to other veterans' hospitals; commentator Boake Carter making the speech for the donor, and War Secretary Woodring accepting.

470,376 commercial scripts were filed by radio stations with F.T.C. during one year, that commission reported last month; of that number, 2,558 were set aside for examination of their contents to determine whether advertising might be false or misleading.

In England, B.B.C. will use a strictly directional mike for pick-up broadcasts; it responds only to lips held close to it, and cuts off when the holder's grip is relaxed. Not only asides and

background noise are cut off, Reynolds stated last month, but it will prevent recurrence of "butting in" by the public, which was becoming a recognized sport, if not cricket.

NBC, having cut Gen. "Ironpants" Hugh Johnson off the air last month, because of difference of opinion as to discussion of "social" (venereal) diseases, was reported threatened with F.C.C. investigation, of attempt to censor campaign started by U. S. Public Health Service. No official confirmation; but NBC made amends by calling Dr. Morris Fishbein, voice of American Medical Association, to speak on subject in "authoritative" manner!

In connection with physical "fitness" campaign in Britain, B.B.C. last month objected that early morning setting-up broadcasts will cost \$25,000 to \$50,000 yearly, because another shift of engineers would be needed. Physical culturists yell: "Hang the expense. We pay for service!"

Campaign against "gyp" dealers in N. Y. City last month resulted in numerous fines, and 6 workhouse sentences, for owners or employees convicted of selling inferior merchandise under well-known brands which had been imitated.

Amalgamation of several groups of servicemen on a national basis as RSA (Radio Servicemen of America) was undertaken last month, and temporary officers elected; under proposed setup, local chapters will be autonomous. Headquarters are 304 S. Dearborn St., Chicago.

**OPERATING NOTES**

(Continued from page 481)

installed in the cabinet, and that ample clearance has been allowed for vanes initially in good condition.

**Stromberg-Carlson Models 130 and 140.** The sensitivity control is a knob on the back of the chassis, to limit the sensitivity on broadcast reception so that the most powerful nearby broadcast station will not cause rectification in the R.F. tube and thus "blanket" the dial. It also is effective on "tweets". Remember to turn this knob clockwise if a newly-installed receiver appears to lack sensitivity.

**Stromberg-Carlson Models 145, 150, 160 and 180.** Normal setting of the fidelity-tone control is at the middle—half red, half white. All red (High Fidelity) broadens the tuning and should not be used for distance reception. All white (Low Fidelity or Tone Control fully operated) causes muffled tone and reduced volume. A definite "bump" when passing through "Normal" shows that the selectivity is maximum and Tone Control is set for Standard Fidelity.

STROMBERG-CARLSON SOLDER NUGGETS

**Grunow Models 700, 701.** After replacing the 2nd I.F. transformer, I was annoyed by complaints of interference from an airport station. The trouble was finally remedied by removing the old I.F. transformers from their cans and connecting the secondaries in series with the antenna lead in the set. The primaries were cut off.

By tuning this homemade wavetrap, the interference was eliminated.

K. W. HOWARD

Please Say That You Saw It in RADIO-CRAFT



**MEN**— here is good news! The Sylvania Technical Manual is now bigger . . . better . . . more helpful than ever. It lists more than 200 tube types, gives important circuit application information on each. Tells all about glass, metal, "G" type and Sylvania "Ballast" tubes, as well as those for Majestic receivers. Contains valuable service helps such as typical circuit diagrams, bias resistor charts, etc. And the Manual's text has been simplified— cross references have been reduced.

To top it all—the Technical Manual now has a new wire binding that makes its pages lie flat . . . a boon to busy servicemen.

If you need radio information, you need this book. Send 25c and the coupon . . . you'll get your copy of the Manual in just a few days.

**SYLVANIA**

SET-TESTED RADIO TUBES

**HYGRADE SYLVANIA CORP. RC-28**  
Emporium, Pa.

Here is 25c. Send me my copy of the new Sylvania Technical Manual.

Name .....

Address .....

City ..... State .....

- SERVICEMAN     EXPERIMENTER
- DEALER         AMATEUR

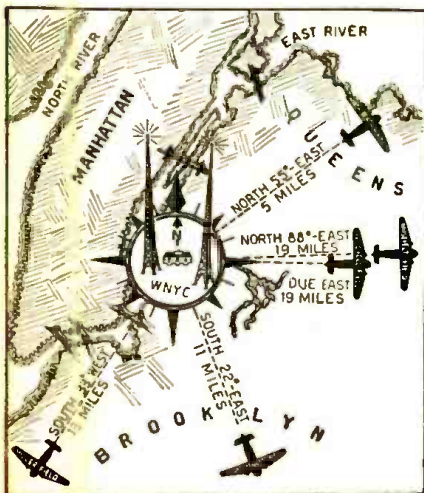

New York City's new transmitter in Greenpoint, Brooklyn, is centrally located to efficiently serve the entire city.





## Good Things In Small Packages

- ★ AEROVOX Type PR tubular electrolytics pack a lot of capacity into a small cartridge. Ideal for filter and by-pass.
- ★ Sturdy cardboard tube. 2½" leads that won't pull loose. Thorough wax sealing.
- ★ 25 to 450 v. working. 5 to 50 mfd. in lower voltages; 2 to 8 mfd. in higher. Also double sections, 25, 50 and 100 v. 5-5 and 10-10.

Ask Your jobber or write us direct for copy of latest catalog listing these PR units and many other condensers.

**AEROVOX**  
CORPORATION  
70 Washington St. Brooklyn, N. Y.  
IN CANADA: AEROVOX CANADA, Limited Hamilton, Ont.

**PRACTICAL  
RADIO  
ENGINEERING**

Don't "sit-down" on the job! Get busy and prepare yourself for the bigger jobs in store for technically trained men. CREI offers home-study training in both Radio Engineering and Service and Public Address work. A post card brings you our 48-page book of interesting facts about your future in Radio—and how we can help you prepare for it.

**SEND FOR  
FREE  
CATALOG**

**CAPITOL RADIO  
ENGINEERING INSTITUTE**  
Dept. RC-2 14th & Park Road, N.W.  
WASHINGTON, D. C.

**RADIO IN IT'S ENTIRETY!**

"It-A" serves the trade with every need in radio—complete 180-page catalog of nationally known radio receivers, public address, parts, supplies and equipment. Orders shipped same day received.

**COMPLETE CATALOG AVAILABLE**

**BURSTEIN-APPLEBEE CO.** 1812-14 MCGEE ST. KANSAS CITY, MO.

**"HAM" SPECIAL** Standard Teleplex

A highly efficient code teacher using heavy specially prepared waxed paper tape, having two rows of perforations. Write for Free folder A-2. We are the originators of this type instrument

Instrument with tapes prepared by expert and complete course; all for \$21.95. Without Oscillator. **TELEPLEX CO.** 72-76 Cortlandt St., N. Y. C.

**\$500,000 GENUINE MAJESTIC-GRIGGS BRUNOW REFRIGERATOR & RADIO PARTS. FOR MODELS PRIOR TO 1936**

**Majestic**

UNITS GUARANTEED 18 MONTHS. SEND FOR PRICE LIST. G & G GENUINE MAJESTIC REFRIGERATOR & RADIO PARTS SERVICE 5801 W. DICKENS AVE. CHICAGO, ILL.

## VOLUME EXPANSION —MODERNIZED

(Continued from page 465)

values will vary with different tubes and only direct tests will enable the user to note the proper plate currents for the best operating condition.

### DIODE TIMING IS IMPORTANT

One other factor that is very important in using any form of volume expansion, is proper timing of the diode voltage on G3. The resistor and condenser marked R1 and C1 in Figs. 3 and 4 form the timing circuit; and, for average speech and music reproduction the values stated in the diagrams are satisfactory. If the time constant is too short, speech then will sound unnatural; and if too long, parts of speech will be carried over and music will drag. This type of distortion is very noticeable when using high percentages of expansion.

An interesting example of time distortion can be studied by listening to Victor record No. 14161, *Italians in Algeria*, Rossini, recorded by Toscanini. Use a high level of expansion and with the values indicated in Figs. 3 and 4 for timing (about ¼-second) note the distortion of the staccato passages. The reduction of the degree of expansion will tend to cover up this time distortion as far as the ear is concerned. However, it is best to speed up the timing if a high degree of expansion is desired.

The *Funeral March of a Marionette*, Victor No. 8661, is another example of the same type. Here the timing circuit should be speeded up if a high percentage of expansion is to be used. Both records reproduce well with a time constant of about 1/10-second.

A satisfactory determination of the time constant when resistance and capacity are employed can be made as follows (Where time [T] is expressed in seconds, Resistance in megohms and capacity in microfarads.):

$$T = R \times C$$

and if the desired time constant is known, then:

$$R = \frac{T}{C} \quad \text{or} \quad C = \frac{T}{R}$$

This method of solution is really "rule of the thumb", but will be close enough to enable the constructor to build a switching arrangement if capacity changes are to be made; or to select a rheostat of the proper value. For example, a rheostat having a range of 5,000 ohms to 0.5-megohm used in conjunction with a capacity of 0.5-mf. will cover a time range of 0.0025- to 0.25-second. Such a control will cover all of the ordinary conditions and if the resistor were to be increased to 1 megohm then the range would be extended to ½-second. This timing would be too slow for speech or music but is given to show the range that can be covered with a single condenser and variable carbon-type rheostat.

Such a control should be conveniently placed for adjustment and calibrated so that the timing for different records can be pre-set before playing.

The author knows many record enthusiasts that have catalogued their records and before playing check the Volume Setting, Per Cent Expansion, and the Time Constant. Of course, this seems like a lot of trouble, but, if realism is desired then somebody has to make the preliminary adjustments.

An attempt is being made in the newer recordings to increase the volume range of the record. The Victor record No. 11932, *Natoma-Dagger Dance*, is an excellent example. This record can be played without expansion and the effect is very satisfactory. However, expansion brings out some of the crescendo passages in a manner that is startling.

A word of warning! Just because we know that records are compressed in recording is no reason that they should be over-expanded in reproduction. Always use the expander as a means of creating an auditory illusion.

## HOW TO RUN A LATHE

The 33rd edition of the well-known machinists' manual, "How to Run a Lathe", has recently been announced by its publisher. The South Bend Lathe Works. This new edition contains 160 pages of fundamentals and practical instructions on every detailed phase of lathe work, in easily understandable language, accompanied by more than 300 illustrations.

*Astounding*  
but it is a fact!  
**The GERNSBACK  
OFFICIAL RADIO  
SERVICE MANUALS**  
(Volume 1 through 6)  
Contain Over 13,000  
Service Diagrams

IN 1931 the first Gernsback OFFICIAL RADIO SERVICE MANUAL was published—each successive year a new volume appeared. Today over 87,000 OFFICIAL RADIO SERVICE MANUALS are being constantly used by radio Service Men.

Every edition of the Manual is an encyclopedia of schematic diagrams. The first six volumes contain over 13,000 wiring diagrams. Rarely comes a set for servicing for which you can't find the diagram and service information you need. Diagrams for sets which were distributed in 1927—and many marketed prior to that date—are published in Gernsback Manuals.

Here is a complete listing of all the Gernsback OFFICIAL RADIO SERVICE MANUALS, including the two volumes of the OFFICIAL AUTO-RADIO SERVICE MANUALS.

Over 1,200 Pages—Over 2,500 Illustrations—\$7.00	<b>1936 MANUAL</b>
Over 1,000 Pages—Over 3,000 Illustrations—\$7.00	<b>1935 MANUAL</b>
Over 400 Pages—Over 2,000 Illustrations—\$3.50	<b>1934 MANUAL</b>
Over 700 Pages—Over 2,000 Illustrations—\$5.00	<b>1933 MANUAL</b>
Over 1,000 Pages—Over 2,000 Illustrations—\$5.00	<b>1932 MANUAL</b>
Over 650 Pages—Over 1,500 Illustrations—\$4.50	<b>1931 MANUAL</b>
Over 240 Pages—Over 500 Illustrations—\$2.50	<b>1933 AUTO-MANUAL</b>
Over 240 Pages—Over 500 Illustrations—\$2.50	<b>1935 AUTO-MANUAL</b>

Any of these Manuals can be ordered by filling in coupon below—and mailing it with your remittance to RAD-CRAFT PUBLICATIONS, Inc., 99 Hudson Street, New York, N. Y.

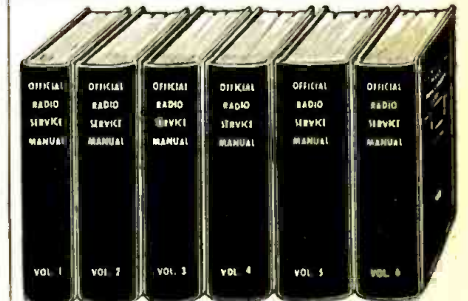

## MAIL COUPON TODAY!

**RAD-CRAFT PUBLICATIONS, Inc. RC-238**  
99 Hudson St., New York, N. Y.

Gentlemen: Enclosed find my remittance of \$..... for which send me POSTPAID One Copy of the ..... OFFICIAL RADIO SERVICE MANUAL. (Send remittance by check or money order. Register letter if you send cash.) This offer is good only in U. S.

Name .....

Address .....

City ..... State .....

Please Say That You Saw It in RADIO-CRAFT



## WESTINGHOUSE UNIVERSAL MOTOR

**\$2.55** 110 Volts AC and DC  
Shipping Weight 3 lbs.

Specifications: 1/30 H.P. operates on either A.C. or D.C., 110 volts, 5000 R.P.M. Rheostat can be used to vary speed. Height 3 1/4", Length 3 3/4", Width 1 3/4", Shaft 1/4", one inch long. Can be used to drive Sewing Machines, Models, Buffing Lathes, Polishing Heads, Drills, Grindstones, etc., etc.

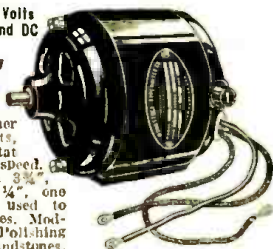

MOTOR only ..... **\$2.55**  
MOTOR with Arbor and 3/4" Chuck ..... **\$3.55**  
Add 25c for special packing and mailing anywhere in U. S. A.

## MICROPHONE and RECEIVER

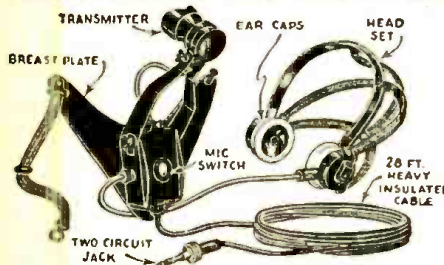

This Microphone and telephone headset outfit was built especially for the U. S. Navy Aviation Corps. The Holtzer-Cabot Electric Company constructed the outfit to Government specifications. The outfit consists of a low-impedance carbon microphone (transmitter), securely fastened to a metal broadcast plate, and a set of heavy-duty, low-impedance earphones. A specially constructed switch on the back of the broadcast plate controls the microphone circuit. The earphones are U.S.N. Utah type, attached to adjustable headband. Twenty-eight feet of very heavy weather and waterproof enamel of cable is furnished. Current of not more than 10 volts could be used. A storage battery is the most satisfactory current supply. U. S. Navy Airplane-type Microphone and Receiver as described ..... **\$4.96**  
The shipping weight is 9 lbs.  
We will forward Shipments by Express Collect sufficient postage is not included.

## WELLWORTH TRADING CO.

560 W Washington Blvd., Dept. RC-2-38, Chicago, Ill.

## Formulas and Recipes

FOR THE PRACTICAL MAN

CONTENTS OF BOOK

1. Adhesives: Glues, Cements, Gums, Mucilages, Lubricants. 2. Cleansing: Stain Removers, Paint Removers, Bleaches, Cleaning Fluids. 3. Metal Craft: Coloring, Oxidizing, Plating, Repairing, Welding, Polishes, Alloys, Solders, Amalgams. 4. Paints: Colors, Stains, Varnishes, Enamels, Luminous Paint, Washable Paint; Paint-Removing, Waterproofing, Fireproofing. 5. Glass-Working: Cutting, Drilling, Boring, Bending, Blowing, Etching, Engraving, Frosting, Silvering, etc. 6. Wood-craft: Fillers, Fireproofing, Acid-proofing, Waterproofing; Furniture Polishes, Finishes, etc. 7. Inks: Recipes, Eradicators, Ink Stain Removers; Special Inks: Colored, Indelible, Sympathetic, Invisible, Hectograph. 8. Photography: Developers, Emulsions, Fixers, Sensitizing, Toning, Printing, Photographic Paper, Blueprint Paper. 9. Antidotes for Poisons, Remedies for Burns and Scalds, Disinfectants, First-Aid in Accidents, Emergency Remedies, Home Remedies. 10. Preparation, Manipulation, Handling, Mixing, Measuring, Weighing, Filtering, Straining Solutions; List of Technical Substances; Emulsifying; Use of Hydrometer, Use of Thermometer; Tables of Weights and Measures, Decimal System, Useful Tables.

Price 50c Postpaid

**TECHNIFAX**

Division RC-238

558 W. WASHINGTON BLVD. CHICAGO, ILL.

## HOW RADIO HANDLED THE ELECTIONS!

(Continued from page 475)

the Mutual chain, was even more elaborate. There were "remotes" from the headquarters of La Guardia, the re-elected mayor, of Mahoney, his opponent, of Dewey and Hastings, the candidates for the office of District Attorney, from the marquee of the Hotel Astor in Times Square and from Trans-Radio News Service, all in New York. These were supplemented by additional spot pick-ups in the headquarters of Senator Moore and from the studio in which Senator Clee, his rival candidate for the governorship of New Jersey delivered a last-minute broadcast. Editorial Rooms of the Newark Evening News—a total of 8 remote points.

WMCA, key of the Intercity Network, went even farther afield with remotes through stations WIP and WMEX giving the local returns from Philadelphia and Boston, respectively. In addition to covering the 2 mayoralty headquarters and Times Square, it had microphones at the Savoy Ballroom in Harlem (New York's negro district), another in Tammany Hall, 1 more in downtown Brooklyn, and 2 others in night clubs, for celebrations and musical interludes. There was still another set-up for a special announcer and a commentator in the studio. As shown in the block diagram, all the pick-ups were coordinated from Studio B. The order wire was utilized as a "cue" system, and announcer, engineer and contact man at remote points were tied-in with earphones. Note that all political headquarters were feeding into the line amplifier simultaneously, together with Studio B and one dance pick-up; in a special release to Radio-Craft, WMCA reports that A DIAL SYSTEM FOR PICKING-UP RADIO LINES ELIMINATED PATCH-CORD OPERATION!

Fifty-odd men at 6 locations handled the elections for CBS, about half of them being on outside duty. These locations, of course, covered the major political headquarters and the police department, but the most interesting work was done in the CBS Building at 485 Madison Ave. As each polling place closed, the votes were taken to the nearest police precinct houses, whence tabulations were phoned to Headquarters on Center St. There 80 policemen and comptometer operators made tabulations, turning their results over to the City News Association, which serviced 7 local newspapers and WABC via teletype. Within 2 minutes after WABC received the data it was tabulated and broadcast. In addition to these city results, CBS put on the nationwide returns as gathered by the Press Radio Bureau from A.P., U.P. and I.N.S. Broadcasts were made from two to three times every 15 minutes during the evening.

NBC likewise gave complete coverage, using the Press-Radio Bureau, with additional set-ups in the headquarters of the more important candidates, at Police Headquarters and in its own truck, Mobile Unit No. 1, which cruised Times Square, relaying "color" to the studios via the short waves. It employed its own crew of tabulators, as did the other large stations.

Thus, within a few moments after the polls closed, radio listeners were made aware of the results of the people's choice—a far cry from the days when our system of elections was begun, when days or even weeks elapsed before the news of the results could travel across the country—when even the candidates themselves often did not learn for some days whether they had risen to triumph or sunk in the ignominy of defeat.

## RADIO, COPPER AND BRASS

Approximately 50,000,000 lbs. of copper and its alloys are used annually in the manufacture of radio receiving sets in this country, exclusive of antennas and ground wires, etc. In one plant alone more than 15 billion feet of copper wire was used; this is enough to make 5 complete loops encircling the earth and the moon. In this same plant nearly 2,000,000 lbs. of wire went into radio speakers and coils, 104,000 lbs. in hookup wire and 107,000 lbs. in the set cord, or plug-in cord. The output transformer and power transformer also contain copper.

In addition a considerable amount of brass goes into the average set. Last year it was reported that over 7,600,000 radio receivers 1,500,000 automobile radio sets and 96,300,000 tubes were sold in this country. It is expected that sales this year will be substantially increased. (COPPER & BRASS BULLETIN)

Please Say That You Saw It in RADIO-CRAFT

## 25,000 OHMS PER VOLT

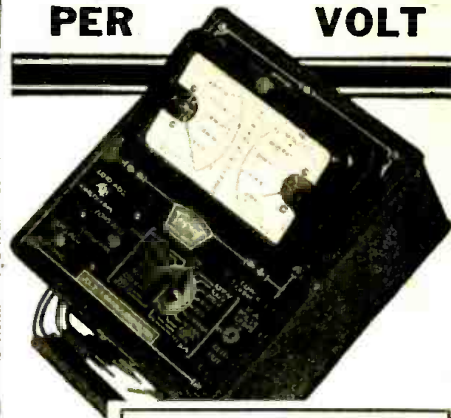

Model 1200-E  
Volt-Ohm-Milliammeter

- Resistance Readings to 40 Megohms
- Separate A.C. and D.C. Instruments in Tilting Twin Case; Accuracy of Each Within 2%
- For All Radio Measurements Not Requiring a No Current Draw Vacuum Tube Voltmeter

Triplet Master Volt-Ohm-Milliammeter Easily Identified by the Exclusive Tilting Twin Instrument, Is by All Odds the Overwhelming Favorite . . . Because It Is the Most Practical.

Model 1200-E offers a new order of precision testing with 25,000 Ohms per Volt. Modern Radio sets that require delicate balancing can be easily and quickly adjusted. READINGS: D.C. Volts 10-50-250-500-1000 at 25,000 Ohms per Volt. A.C. Volts 10-50-250-500-1000. 50 D.C. Microamperes. 1-10-50-250 Milliamperes; Resistance 1/4—1000 Low Ohms; Backup Circuit; 0—40,000 Ohms; 4 and 40 Megohms.

A TRIPLET MASTER UNIT . . . one of a series of co-related single unit testers made in standard sizes, the most economical method yet devised for completely equipping the all-around radio service shop with high quality instruments. Catalog gives complete information regarding other Triplet Volt-Ohm-Milliammeters.

## New LABORATORY TEST BENCH PANEL

As Shown Contains:

- 1210-A Tube Tester
- 1232 Signal Generator
- 1209-A A.C. Volt meter
- 1209-D.C. Volt-Ohm-Milliammeter

OTHER LABORATORY MODELS

Model 1402 with compartments for any two DeLuxe Testers.

Model 1403 with accommodations for any two Master Units and one DeLuxe Tester.

Model 1404 Dealer Price \$95.50 (complete less lamp)



TRIPLET Precision

## ELECTRICAL INSTRUMENTS

THE TRIPLET ELECTRICAL INSTRUMENT CO.  
162 Harmon Dr., Bluffton, Ohio.

Please send me more information on Triplet Model

1200-E \_\_\_\_\_; Model 1404 \_\_\_\_\_

Name \_\_\_\_\_

Address \_\_\_\_\_

City \_\_\_\_\_

State \_\_\_\_\_



## BETTER CONDENSERS

mean . . .  
MORE PROFITABLE SERVICING



Cornell-Dubilier type JR etched foil dry electrolytics solve the toughest condenser replacement problems. Impervious to heat and moisture, JR's are TRIPLY-SEALED, yet small enough to fit in 'most any place. Housed in handsome silvered containers with sturdy mounting feet and color-coded leads. Don't wait until you need them—write for catalog TODAY!

Cornell-Dubilier Electric Corporation  
1014 Hamilton Blvd.  
So. Plainfield, New Jersey

### CORNELL-DUBILIER CORP.

SOUTH PLAINFIELD, NEW JERSEY

## DON'T!

**BUY ANY AMPLIFIER OR PUBLIC ADDRESS SYSTEM**

until you read our bulletin describing a new line of 1938 amplifiers designed by A. C. Shaney featuring:

- Audio Spectrum Control
- Cathode-Drive Amplification
- Automatic Feedback Suppression
- F.V.F.B. Beam Power Amplification
- Automatic Audio Volume Control
- Floating Audio Power
- Plus many other exclusive features.

Our Amazingly Low Prices, Free Trial Offer, and Usual Five Year Guarantee Make it Well Worth Your While to Write To-Day for Free Bulletin No. PA 3810. Free P.A. Consulting Service.

**AMPLIFIER CO. OF AMERICA**  
37-47 West 20th St., New York, N. Y.

## YOU CAN!

### CONTROL YOUR FATE

Only one power controls your destiny—a strange force sleeping in your mind. Awaken it! Command it to obey you! Push obstacles aside and attain your fondest hopes and ideals. The Rosicrucians know how.

WRITE FOR FREE BOOKLET

Learn why great masters through the ages were Rosicrucians. Free booklet tells the fascinating story of this age old Fraternity and how to obtain its priceless teachings. Write to: Scribe V.A.K.

**THE ROSICRUCIANS (AMORC)**  
SAN JOSE, CALIFORNIA

### Vest Pocket Adding Machine



Sturdy Steel Construction. Lifetime Pocket Companion. Adds, Subtracts, Multiplies, Divides. Capacity, 999-999.99. A real machine—guaranteed 5 years. Send name and address. We ship immediately. On delivery, pay postman \$2.50 (plus few cents postage). (Foreign countries send cash.) Your money back after 10 days trial if not satisfied! Thousands of satisfied users. Send for Special Offer to agents.

Free Trial \$2.50 Total Cost

TAVELLA SALES CO., 21 West Broadway, New York, N. Y.

### Correspondence Courses in RADIO and ELECTRICAL ENGINEERING

**ELECTRICAL ENGINEERING** Get good grasp of wide electrical field. Prepare yourself, at Low Cost, for secure future. Modern, simplified, you can understand quickly.

**RADIO ENGINEERING** Extra fine course in radio, public address, photo-electric work. Trains you to be super-service man, real vacuum tube technician. Excer. kits furnished. Diploma on completion. Tuition, \$25. either course, deferred payment plan. Get copies of school catalogs, student magazines, complete details. SEND NOW!

**FREE**

LINCOLN ENGINEERING SCHOOL, Box 931-64, LINCOLN, NEBR.

### MODERNIZE YOUR OBSOLETE TUBE CHECKER OR SET ANALYZER with "PRECISION"

Write for details. Mention make and model number of your old instrument.

**PRECISION APPARATUS CORP.**  
4821 EAST NEW YORK AVE., BROOKLYN, N. Y.

## 2,000 PARTS MAKE MODERN RADIO SET!

(Continued from page 483)

1,500 feet of wire, hundreds of feet of wax-impregnated paper, 300 pieces of steel, and coils of 500 to 1,000 turns. The condenser and other pre-fabricated equipment would bring the total number of separate parts in a modern radio set well beyond the figure of 2,000 in an automobile.

There is, for example, the question of wiring. Engineers calculated, matter-of-factly, that the 20-tube set contains 15,095 feet of wiring—nearly 3 miles of wire. This is not a single piece of wire. There are hundreds of separate connections to be made, many of them using an inch or less of wire.

In the loudspeaker alone, there is approximately one mile of wiring. Some of the wire is only half as thick as a human hair, so that what appears to be a single small strand is in reality often several strands so small as to be almost invisible.

On the average, 31 man-hours are required to assemble the 20-tube set. While they are called "man-hours" much of the work is done by girls. Each has a specialized operation. The average good mechanic, lacking the benefit of the system of specialized work and speed that comes from repetition of motions, would take months to assemble a radio set.

Radio engineers estimate that the assembly of a 20-tube set involves at least 40,000 motions to fit together the 987 parts that come from the stock room. This number of motions, of course, would be increased greatly if the work on the tubes, transformers, condensers done in the factories of the special parts manufacturers—were taken into account.

Once the set is assembled and has been put through scores of tests to determine whether the assembly line has properly done its work of fitting together the hundreds of parts and connected them with the thousands of feet of wiring, another department gives the set a special "shake" test.

A vibrator machine jolts and jars the finished set and quickly reveals loosened connections or improperly fitted parts. Other testing devices check the accuracy of the thousands of feet of wiring.

*This article has been prepared from data supplied by courtesy of Midwest Radio Corp.*

## IF THEY ONLY KNEW!

Some old-timers in radio production were recalling devices set up to fool artists who made out-of-the-way demands. Jessica Dragonette, a stickler on fresh air, used to complain about the air in the studio frequently. The program director would pick up a "dead" studio telephone and go through elaborate pretense of severely reprimanding the ventilation engineer. The air was fresh then.

Ed Wynn wanted 3 microphones so he could turn around as he spoke. The engineers gave him his 2 extra mikes, one on either side—connected to nothing. The stand for the one "live" microphone had to be mounted on rubber sponges during a Wynn program. Ed stamps around the studio stage as he broadcasts, and those stamps would be picked up as dull booms.

The most famous of all those devices was one rigged up for Leopold Stokowski in an early symphony broadcast. He insisted that he, and not an engineer, should be the one to operate the control board regulating volume. They gave him a dummy board and he worked meticulously on the dials. The actual control operation, however, was done by an engineer in another part of the studio.

We would like to credit the New York City newspaper from which this was clipped but, regret that its name was (by oversight) not attached to the clipping.—Editor

## A LOT OF SETS!

It is estimated that there are in the world today over 56,225,000 radio sets and that approximately 30,000,000 of these units are in use in the United States alone. About 24,269,000 families in this country have receivers, many have more than one set, and 4,000,000 automobiles are equipped with radio sets.

(COPPER & BRASS BULLETIN)



**NEW!!!**  
**Envo-letter**  
PERSONAL STATIONERY \$1

**A PRACTICAL LETTERHEAD AND ENVELOPE COMBINED!**

THIS remarkable newly patented stationery is sweeping the country. No sheets or envelopes to waste—it's a letterhead and envelope combined. Write on three large pages—then fold into a securely sealed envelope with your name and address printed on the sheet and visible through novel cut-out feature on envelope flap. This also serves as return address for postman.

**ORDER TODAY**  
Saves you time and money—order a supply of personal stationery NOW

**50 ENVO-LETTERS for \$1.00**  
**SPECIAL OFFER — 150 ENVO-LETTERS \$1.50**  
Shipment made within five days.

The paper is of exceptional quality—supplied in White, Ivory and Grey granite. Printing colors—black, blue, red or brown. Guaranteed satisfaction or money refunded. Be sure to print your name, address, city and state to insure accuracy.

Send check or money order for full amount—register letter if you send cash or stamps. Mailed POSTPAID in U. S. A.

**PRIVATE STATIONERY COMPANY**  
246 FIFTH AVENUE Dept. RC-238 NEW YORK, N. Y.

## NO REASON Why YOU SHOULDN'T PROFIT FROM Servicing Tips FEATURED IN BERNSELY'S Official Radio Service Handibook

PROFESSIONAL men like to learn new things about their business—and we've found that things men are wise to the "tricks" also. That is why thousands of radio Service Men constantly refer to Bernsley's OFFICIAL RADIO SERVICE HANDBOOK. It has the servicing tips your business requires—and many more besides. The HANDBOOK is the "by word" among crackerjack radio men.

**HERE ARE THE OUTSTANDING FEATURES**

Special section exceeding 250 pages of Operating Notes for Standard Receivers • Circuit Theory and Analysis • Servicing Equipment • Standard and Specialized Receiver Installations • Modernization and Conversion Data • Social and Economic Problems of the Service Man. In all there are over six hundred topics covered—with illustrations and Photographs aplenty.



It's a text book every radio Service Man needs—it's a comprehensive volume of

**Over 1,000 Pages**  
**Over 1,000 Illustrations**

It is sturdy bound to assure rough usage—and it has an attractive, stiff linen cover with title stamped in gold letters. Conveniently sized—6 x 9 inches—and weighs over two pounds.

**RADCRAFT PUBLICATIONS, Incorporated**  
99 Hudson St. New York, N. Y.

RADCRAFT PUBLICATIONS, Inc. HC-238  
99 Hudson St., New York, N. Y.

Gentlemen: Please send me on FIVE-DAY APPROVAL, One Copy of BERNSELY'S OFFICIAL RADIO SERVICE HANDBOOK. If I retain the book, I will remit promptly the amount of \$4.00. Should I return the book, I pay only the mailing costs to you.

Name \_\_\_\_\_

Address \_\_\_\_\_

City \_\_\_\_\_ State \_\_\_\_\_

Employed by \_\_\_\_\_

(This offer is good only in U.S.A.)

Please Say That You Saw It in RADIO-CRAFT



## THE LATEST RADIO EQUIPMENT

(Continued from page 479)

obtained quickly or conveniently. Incidentally this accurate lathe has additional interest for the hobbyist and for small-part engineers, model makers, inventors, jewelers and home-crafters. This screw cutting lathe is back-gearred to facilitate such operations as turning, facing, threading, tapering, boring, knurling, cutting-off, and mica undercutting.

### WIRE-TYPE INTERPHONE (1557) (The Turner Co.)

ALTHOUGH only the master unit of this A.C.-D.C. "P.D.Q." system, as it is called, incorporates an amplifier, the remote unit may call and talk to the master. The volume is controlled only from the master station. The amplifier incorporates 1-6C6, 1-43, and 1-25Z5. Finished in silk suede.

### "PIE-WOUND" PRECISION RESISTORS (1568)

HERE is vital information for the technician to whom the word "precision" is of importance.

Just announced, is a 1-watt "Riteohm 81" resistor, precise to within 1 per cent, which is ideally suited to the exacting requirements of voltmeter multipliers, in laboratory equipment, radio and electrical test sets, and in many similar applications.

The "vacuum impregnation" process used consists of placing the wound unit in a sealed chamber which is then highly evacuated, withdrawing all the air between the turns, and per-



New line of "pie-wound" precision resistors. (1568)

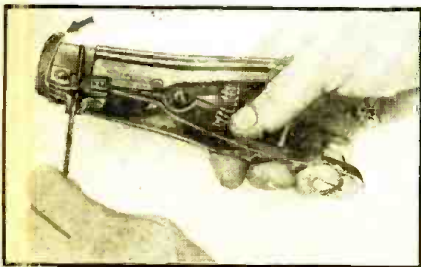

Improved "automatic" wire stripper. (1569)

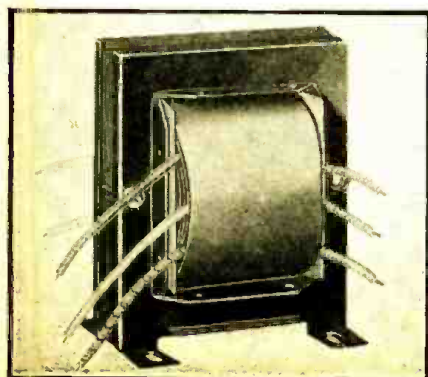

New line of vibrator transformers. (1570)

mitting the insulating and moisture-sealing compound to completely saturate the winding. This results in a hermetically-sealed winding permanently protected against moisture, and so solid as to transfer heat more rapidly than looser windings. The process also produces exceptionally high insulation resistance against voltage breakdown.

A non-inductive winding, on a non-hygroscopic ceramic core, is obtained by reversing the direction of winding of alternate "pies" or sections. This construction also reduces distributed capacity; and skin effect is kept to a negligible value even at high radio frequencies. The unit (illustrated) is about 2 ins. long.

### "AUTOMATIC" WIRE-STRIPPER (1569)

THE RADIO man's tool here illustrated was developed to meet the insistent demand for a wire-stripper that would permit stranded wire to be removed from an existing radio and electrical tool (the E-Z Wire-Stripper described, in this department, in a past issue of *Radio-Craft*) after it had been stripped and before the return of the jaws. A little stop-bar (arrow) does the trick.

An indispensable, dependable tool for fast work both inside and outside the shop.

### VIBRATOR TRANSFORMERS (1570)

TWO "vibrator" transformers have been added to a well-known line of transformers. They are designed for replacement in automobile receivers; and, for use with mobile or portable transmitters and receivers used in amateur work.

Both these transformers are used in conjunction with a vibrator unit and rectifier to operate from a 6-volt D.C. source. One unit delivers 245 volts D.C. at 40 ma.; the other delivers 295 volts D.C. at 45 ma. or 270 volts at 67 ma.

## 4 Free LESSONS in TELEVISION

### What Do You Know About Television? CAN YOU QUALIFY?

Television is much closer than you imagine. Already commercial in England... Just a few details remain before it will be announced here. When it "breaks" there will be a wild scramble for TRAINED TELEVISION MEN. Do you know Television fundamentals? Cathode-ray tube construction? Television transmission and reception? American Television Institute is one of the best equipped Television Laboratories in the world. Under supervision of Mr. U. A. Sanabria, one of the world's foremost television authorities. Let us train you for Television positions earning \$1500, \$2500 to \$20,000 a year. We accept only applicants who can pass the examinations on the first four lessons. WE WILL ACTUALLY SEND UP TO FOUR LESSONS WITHOUT COST OR OBLIGATION, so you may determine how A. T. I. training will benefit you, and equip you for a future in radio and television. Tuition on easy time payments. Complete full-sized "professional" Television equipment included with each course.

## FREE!

We have compiled what we believe is the most interesting and authentic data on Television you've ever read. It's yours FREE for the asking. Gives you real INSIDE FACTS. Technical details... diagrams... Illustrations... cathode ray tube construction data... Television operation and transmission... and hundreds of other important, interesting FACTS about Television. We will send this data without cost or obligation. Clip coupon below and mail it to us NOW!

### AMERICAN TELEVISION INSTITUTE

433 E. Erie St., Chicago, Ill. RC238

Gentlemen: Please send me your free Television book, literature and first 4 lessons, with which I would like to be tested. It is understood that all this is free.

Name ..... Age .....

Street .....

City ..... State .....

## THIS POCKET VOLT-OHM-MILLIAMMETER DOES ALL YOUR D.C. TESTING

### ASK YOUR JOBBER TO SHOW YOU THE DIFFERENCE

• Model 735 has a Triplett D'Arsonval type precision instrument with easily readable scales. Ranges are 15-150-750 volts at 1000 ohms per volt; 1 1/2-15-150 M.A.; 1/2-1000 low ohms; 0-100,000 high ohms at 1 1/2 volts. Provisions for external batteries for higher resistance measurements. Has selector switch for all ranges and individual zero adjustment for resistance measurements. Now with silver and black etched panel.

### ASK YOUR JOBBER — WRITE FOR CATALOG

READRITE METER WORKS  
216 College Ave., Bluffton, Ohio  
Without obligation please send me more information on Model 735. I am also interested in

Name .....

Address .....

City ..... State .....



PRECISION BUILT \$10.80

MODEL 735  
ACCURACY 2%  
BATTERY, TEST LEADS AND ACCESSORIES INCLUDED

Please Say That You Saw It in RADIO-CRAFT





# BRINGS YOU ANY ONE OF THESE 4 FAMOUS RADIO BOOKS

RADIO FANS! Help yourselves to a radio education for the price of 10c per book. These books give you a good foundation towards the study of radio. You'll be amazed at the wealth of information contained in them. They are especially written for beginners but are useful review and reference books for all.

Each book contains 32 pages, profusely illustrated with clear, self-explanatory diagrams. They contain over 15,000 words of clear legible type. They are an education in themselves and lay the groundwork for a complete study of radio and electricity.

### HOW TO BUILD FOUR DOERLE SHORT-WAVE SETS

Due to a special arrangement with the publishers of **SHORT WAVE CRAFT**, we present in this book complete details for building the Doerle sets, also an excellent power pack if you plan to electrify any of the sets. Contains EVERYTHING that has ever been printed on these famous receivers. These are the famous sets that appeared in **SHORT WAVE CRAFT**: "A 2-Tube Receiver that Reaches the 22,500 Mile Mark," by Walter C. Doerle, "A 3-Tube 'Signal Gripper,'" by Walter C. Doerle, "The Doerle."

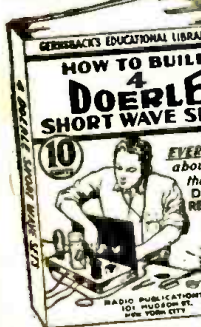

2-Tube "Adapted to A. C. Operation," "The Doerle 3-Tube 'Signal Gripper' Electrified," and "The Doerle Goes a 3 and a Half Miles." Has 30 illustrations. **10c postpaid**

### HOW TO MAKE THE MOST POPULAR ALL-WAVE 1- AND 2-TUBE RECEIVERS

This book contains a number of excellent 1- and 2-tube sets, some of which have appeared in past issues of **RADIO-CRAFT**. These sets are not toys, but have been carefully engineered. They are not experiments. To mention only a few of the sets the following will give you an idea. The Megadyne 1-Tube Pentode Loudspeaker Set, by Hugo Gernsback—Electrifying The Megadyne—How to Make a 1-Tube Loudspeaker Set, by W. F. Chesney—How to Make a Simple 1-Tube All-Wave Electric Set, by F. W. Harris—How to Build a Four-in-Two All-Wave Electric Set, by J. T. Bernsley, and others.

Each set is fully described in simple language so that anyone can build with limited means, and with practically no experience & worth-while all-wave radio set. Has 30 illustrations. **10c postpaid**

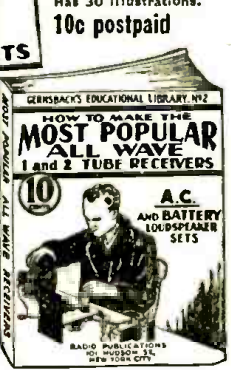

### ALTERNATING CURRENT FOR BEGINNERS

This book gives the beginner a foothold in electricity and radio. Electric circuits are explained. This includes Ohm's Law, alternating current, sine waves, volts, amperes, watts, condensers, transformers, motors and generators, A.C. instruments, house-wiring systems, electrical appliances and electric lamps. Here are some of the practical experiments which you can perform. Simple tests for differentiating between A.C. and D.C.; how to light a lamp by induction; making a simple electric horn; demagnetizing a watch; testing motor armatures; charging storage batteries from A.C. outlet; testing condensers with A.C.; making A.C. electromagnets; trying eggs on a cake of ice; testing a transformer with A.C. motors and many others. Has 42 illustrations. **10c postpaid**



### ALL ABOUT AERIALS

In simple, understandable language this book explains the theory underlying the various types of aerials; the inverted 'L', the Doublet, the Doublet, etc. It explains how noise-free reception can be obtained, how low-impedance transmission lines work; why transposed leads are used. It gives in detail the construction of aerials suitable for long-wave broadcast receivers; for



short-wave receivers, and for all-wave receivers. The book is written in simple style. Various types of aerials for the amateur transmitting station are explained, so you can understand them. Has 66 illustrations. **10c postpaid**

Remember that each book has 32 pages and contains over 15,000 words. Each book has from 30 to 66 fine illustrations. **POSITIVELY THE GREATEST 10c VALUE IN RADIO BOOKS EVER OFFERED TO THE PUBLIC.**

If you do not think that these books are worth the money asked for them, return them within 24 hours and your money will be instantly refunded.

Send for our **FREE circular listing 48 new 10c Publications**

**RADIO PUBLICATIONS**  
99A Hudson St., New York, N. Y.

**RADIO PUBLICATIONS** 99A Hudson Street, New York, N. Y. RC-2-38

Please send immediately **POSTPAID** the books checked:

No. 1—How to Build 4 Doerle Short Wave Sets.....10c

No. 2—How to Make the Most Popular All-Wave 1- and 2-Tube Receivers.....10c

No. 3—Alternating Current for Beginners.....10c

No. 4—All About Aerials.....10c

I am enclosing..... the price of each book is 10c

Send me **FREE** circular listing 48 new 10c publications

Name .....

Address .....

City .....

(U. S. Coin or U. S. Stamps acceptable.) Books are sent postpaid.

## THE LATEST RADIO EQUIPMENT

(Continued from page 478)

### LINE-NOISE ANALYZER (1545) (Aerovox Corp.)

**T**HIS READILY-PORTABLE device comprises various forms of filters thrown into circuit by a selector switch. Unit connects between noise-producing appliance, or set, and line. After adjusting for minimum noise, the analyzer indicates by factory type number the standard type filter to use in duplicating the same setup. When not in use, the attachment cords, plugs and connectors fit into a compartment with hinged cover.

### "INSTANTANEOUS HEAT" SOLDERING SYSTEM (1546)

**A** PATENTED electric soldering outfit, operating on an improvement over the principles described in a past issue of *Radio-Craft* (July, 1936), employs a small arc for the heat production instead of either the usual live-voltage wire heating unit or the less common direct-contact low-voltage carbon type.

Solder heat is produced almost instantly. Said to be absolutely safe to use even when standing on a concrete floor. Screw control provides exact arc-gap adjustment. Switch on side permits control, by the user's thumb, of rapid heating and cooling so that difficult soldering is readily accomplished. Power is used only when switch is depressed; thus in intermittent use, as in the radio and electrical repair fields, monthly power consumption is only a fraction of the usual amount. Kit includes an "iron", transformer, stand and 3 extra electrodes; shipping weight, 5 lbs.

### REFRIGERATION SERVICE THERMOMETER (1547)

**M**ANY radio Service Men are employed by concerns that handle refrigerators and in the course of their day's work these radio men very often are called upon to service the company's refrigerator line. As an aid to speedier servicing there has been developed the "Service-man" refrigeration service thermometer. Unlike previous types of refrigerator thermometers this new instrument incorporates a "recalibrator"—if, following an accident, a thermometer is found to be off-calibration "you simply place the thermometer bulb in a bowl of crushed ice and water and turn calibrator screw until the pointer registers 32 deg."

### HANDIEST MOUNTING (1566)

**U**NDoubtedly the handiest pilot-bulb mounting to come down the line, so far, is the cadmium-plated one here illustrated. Removable bull's-eye permits removing pilot bulb from front; removable bulb enables bulb to be replaced from rear. Frosted bull's-eye appears white until pilot lights, whereupon it becomes a brilliant red; other color-disks are available.

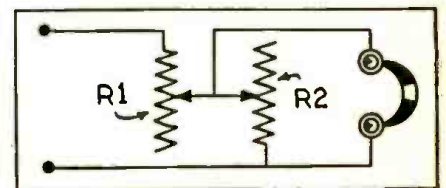

Circuit of item No. 1537 shown on pg. 478.

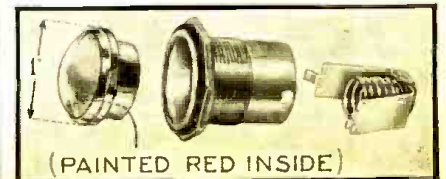

New pilot light mounting assembly. (1566)

## ELECTRO BROILER — Every Home Needs It!

• LATEST COOKING INNOVATION — MAKES TASTIER MEALS •

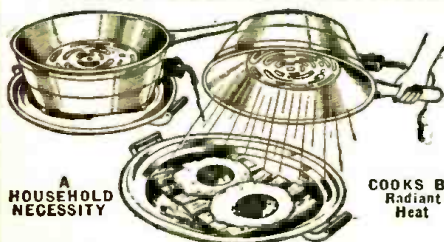

**A** REAL cooking necessity—ELECTRO BROILER broils meat, fowl or fish—quickly and conveniently—without cooking odors. Makes food tastier by retaining all the juices and flavor—cooks by radiant heat. Simple and inexpensive to operate—use standard A.C. or D.C. current. Convertible for toasting or boiling—can be used as electric stove.

Constructed of steel with attractive bakelite fittings—wood enameled handle permits easy handling. Complete unit—serving tray, cover with heating unit and electric cord.....postpaid **\$6.95** anywhere in U.S.A.

Send check or money order (registered letter if you send cash or stamps) to

**HUDSON SPECIALTY COMPANY, 40-R West Broadway, New York, N. Y.**

### FREE POST CARDS MAY BE HAD UPON WRITING TO THE PUBLISHER

These post cards make it easy to answer advertisements which appear in *Radio-Craft*, without cutting valuable data which you may wish to save. So send for a supply of free post cards and use them in answering all *Radio-Craft* advertisers.

Please Say That You Saw It in **RADIO-CRAFT**



## ELEMENTARY PROCEDURE FOR SERVICING RADIO SETS

**I**N THE PAST it has been the practice of manufacturers to issue a service manual each time a new model was brought out. Due to similarity of circuits this has resulted in much unnecessary repetition. It is believed that information can be compiled, general enough, to cover all the important phases of servicing past, present and future models.

### THE PROCESS OF ELIMINATION

While the trouble is immediately apparent on some service jobs, in the majority of cases it is necessary to locate the defects by the process of elimination. In comparison with the production problems, the Service Man has a relatively simple problem to face as he knows the radio was operating properly when shipped from the factory and failure must be due to breakdown of one or more parts in the radio set. In the case of a set which is completely inoperative the tracing should always commence at the rectifier-filter circuit and work back through the audio circuits, through the I.F., R.F., etc., to the antenna circuit.

### "A" AND "B" CIRCUITS

First study the circuit diagram. Notice whether filaments are wired in series or parallel. In series filament circuits as used in A.C.-D.C. sets, the burn-out of one tube or the opening of the filament series resistor will make all tubes fail to light. In parallel filament circuits a burned-out tube will show up at once as the other tubes remain lighted.

Absence of "B" voltage may indicate a defective tube, open filter choke or speaker field (if such is used in place of a filter choke), short-circuit or poor connection. A short-circuited filter condenser may have caused the rectifier tube to become inoperative.

Low "B" voltage may indicate a worn out rectifier tube, partial short-circuit at some location in the set (usually through a resistance or leaky condenser), open filter condenser or incorrect bias caused by faulty resistor.

### OTHER TESTS WHEN SET IS "DEAD"

If "A" and "B" voltages seem correct but set is "dead," test for open speaker winding, defective tubes, defective bypass condensers, open connections or wiring shorts. It is advisable to keep a set of "master" tubes which are known to be in good condition, for comparative purposes.

### WEAK OR POOR SENSITIVITY

These conditions are generally caused by weak tubes, leaky or open bypass condensers, resistors whose values may have changed (may also cause overload), damaged coils, or incorrect adjustment of tunable circuits either R.F. or I.F. methods of testing condensers and resistors and of adjusting tunable circuits will be given subsequently.

### RESISTOR AND CONDENSER TESTS

A continuity meter consisting of a voltmeter and battery may be used for testing resistors. Its usefulness is limited however, to the operator's familiarity with the drop to be expected through various resistances. A simple ohmmeter of the type put out by the better known meter manufacturers is highly recommended. It is one of the most useful pieces of equipment in any service department.

If you want a very simple and useful condenser test, purchase a 2-watt neon lamp from any radio mail order house. Connect this as you would a voltmeter for continuity test using approximately 90 volts of "B" battery. An "A-B" eliminator may be used in place of the batteries if it is filtered sufficiently so the A.C. component is practically nil.

Condensers should be disconnected before being tested. There should be an instantaneous flash in the neon lamp as the circuit is completed across the condenser being tested. On small condensers this flash will be very small and of short duration. The brilliancy and duration of the flash are a rough indication of the capacity. The test should be maintained over a period of possibly 1/2-minute. When testing paper or mica condensers there should be no light in the neon lamp other than the initial flash. No flash indicates an open condenser. Sustained or fluttering illumination indicates a leaky condenser which should be

replaced. A good electrolytic condenser, due to the leakage through it, will allow a rhythmic flutter.

The duration, rapidity and brilliancy of the flashes are governed by the capacity of the condenser.

### OSCILLATORS AND OUTPUT METERS

While it is possible to do a certain amount of balancing and aligning without the aid of a signal generator and output meter it is not easy to approach the accuracy that can be obtained with their use. The well-equipped service department should have an oscillator that will generate modulated signals of frequencies suitable for adjusting the I.F. transformer assemblies in super-het. models and frequencies useful in aligning the tuning condensers on broadcast and short-wave bands. The harmonics of signals in the broadcast band may often be used in checking and adjusting the short-wave bands if the test oscillator does not cover the whole spectrum desired.

The standard type of A.C. output meter is satisfactory on all models not using A.V.C. When A.V.C. is incorporated in the radio set a microammeter with any convenient range up to 500 microamperes with a 1-megohm variable resistance in series should be used in place of the usual output meter. The variable resistance acts not only to protect the meter but allows adjustment to the most convenient portion of the scale. In practice, this assembly is connected across the manual volume control and reads A.V.C. voltage developed. Adjustments are made for maximum reading.

An alternative method, though not as satisfactory, is to connect a 0-10 ma. D.C. milliammeter in the "B"-plus lead to the primary of the last I.F. transformer to read plate current. Adjustments are made for minimum reading.

### ALIGNING AND BALANCING

When it is necessary to rebalance or realign the tuning circuits due to damage, tampering or coil changes the procedure will be found similar on all models.

### T.R.F. CIRCUITS

Set the signal generator at a frequency near 1,500 kc. Tune the radio set to resonance with this signal and adjust the small trimmer con-

*(Continued on following page)*



**-with Centralab  
in  
at the Controls!**

Old Man Centralab at the joy stick! . . . playing a rather "heavy" part in the "Drama of the Skies" as produced by Bendix Radio.

Old Man Centralab is mighty proud of his performance . . . just as he is proud to be associated with Bendix, ace designers and builders of aviation communication systems. Whether for intricate "two way fone systems," or just plain and fancy replacement jobs — insist on Centralab parts.



# Centralab

MILWAUKEE WISCONSIN  
BRITISH CENTRALAB, LTD.  
Canterbury Rd., Kiburn  
London N.W. 6, England  
FRENCH CENTRALAB CO.  
118 Avenue Ledru-Rollin Paris XI, France



*Everything Sold on Time Payments*

# SAVE

Get the latest and finest radio equipment at rock-bottom prices! Use it while you're paying for it on convenient monthly terms. Send for Wards new 1938 Radio Catalog—the finest ever printed. See how much you can save and how easily you can buy the radio equipment you need. Mail the coupon NOW for your FREE copy!

## Montgomery Ward

MONTGOMERY WARD, DEPT. RZ-6  
CHICAGO, ILLINOIS

Send me my FREE copy of Wards new 1938 Radio Catalog. I am particularly interested in the equipment checked at left.

Name .....

Address .....

City .....

<input type="checkbox"/> Sound Systems and Equipment	<input type="checkbox"/> "Ham" Receivers and Supplies
<input type="checkbox"/> Inter-Communication Systems	<input type="checkbox"/> Testing Instruments and Books
<input type="checkbox"/> "Ham" Transmitters and Parts	<input type="checkbox"/> Replacement Supplies and Parts

Please Say That You Saw It in RADIO-CRAFT



AS NEW TODAY  
AS TOMORROW'S NEWS:

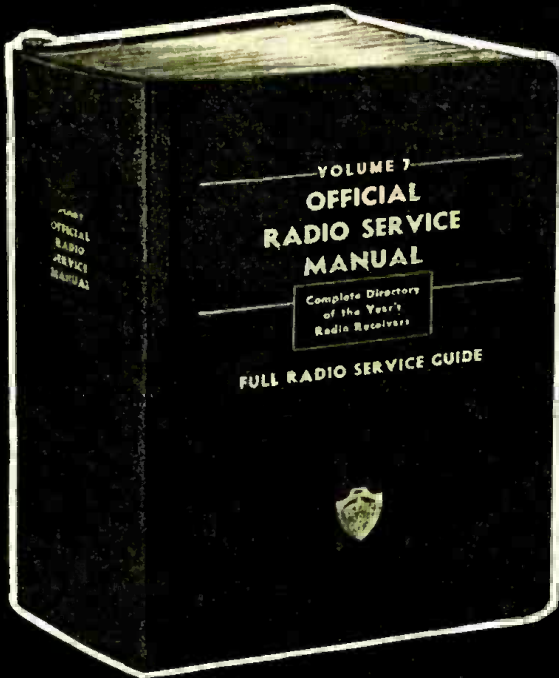

VOLUME 7  
OFFICIAL RADIO SERVICE MANUAL

OVER  
**1,800**  
PAGES  
★  
OVER  
**3,000**  
ILLUSTRATIONS  
★  
SIZE: 9" x 12"

COMPARE other service manuals with the new GERNSBACK OFFICIAL RADIO SERVICE MANUAL (Volume 7) as it is published today. You'll find the GERNSBACK MANUAL, by far more complete in service information — more up-to-the-minute with present-day receiver diagrams — and published entirely differently than in previous years.

Most important of many innovations are the month-to-month installment method of publishing Volume 7—and the deferred payment plan which makes it convenient for every Service Man to own radio's greatest of service manuals. Write today for descriptive literature which gives complete information about Volume 7 of the OFFICIAL RADIO SERVICE MANUAL—and the plan which tells how to pay-as-you-compile your Manual. Mail the coupon below—**TODAY!**

**RADCRAFT PUBLICATIONS, Inc.**  
99 HUDSON ST., NEW YORK, N. Y.

RADCRAFT PUBLICATIONS, Inc., 99 Hudson Street, New York, N. Y.

RC-238

Gentlemen: Please send me descriptive literature on Volume 7 of the GERNSBACK OFFICIAL RADIO SERVICE MANUAL—and details for buying this edition on the deferred payment plan.

Name .....

Address .....

City ..... State .....

Please Say That You Saw It in RADIO-CRAFT

(Continued from preceding page)

densers on the tuning condenser for maximum output.

Next set the signal generator at 1,000 kc. Insert a thin bakelite, celluloid or mica feeler strip between the plates of the variable condensers to determine whether the circuits are properly matched. The action is this—the dielectric constant of the celluloid feeler strip being higher than that of the air it displaces, results in an increase of capacity.

Open the variable condenser just enough to indicate 2 or 3 points below maximum signal. As the feeler is inserted the meter reading should indicate increasing signal and then decreasing as the feeler is inserted farther. This procedure should be followed on all sections. Should the meter fail to show an increase in signal as the strip is inserted in one section this indicates too great a capacity for that section. This may be corrected by bending the outside rotor plates out at the point where they mesh with the stator.

After checking the alignment at 1,000 kc., repeat the process at 550 kc.

**SUPERHETERODYNE CIRCUITS**

It is customary to check the adjustment of the I.F. units before aligning the variable condenser. When doing this, the oscillator section of the variable condenser should be shorted-out so no oscillation will be generated in the radio set. The signal generator should be set at the proper intermediate frequency and its output connected to the antenna connection of the radio receiver. The valuable adjustments on the I.F. units should then be checked for exact resonance as indicated on the output meter. It is well to go over these adjustments more than once.

When the I.F.'s are properly adjusted, the variable condenser may be balanced and aligned following the directions given for T.R.F. circuits. It is not advisable to bend plates on the oscillator section unless absolutely necessary. The other sections should be aligned to the oscillator section if possible.

In sets having an adjustable oscillator pad it is customary to first adjust trimmer condensers at 1,500 kc. and then go to 550 kc., and adjust the pad. While the condenser is rocked slowly back and forth across the signal the pad is adjusted for maximum output.

In sets incorporating a short-wave band, a vernier tuning condenser is provided so it is not necessary to worry about alignment after the set has been properly aligned on the broadcast band. Where needed, extra trimmer condensers are provided which are to be adjusted at the high-frequency end of the short-wave bands. Instead of bending condenser plates at the low-frequency end, alignment is accomplished by spreading or crowding turns on the short-wave antenna coil.

**I.F. INTERFERENCE**

In some few sections of the country there are airport or other commercial transmitters operating on or near the intermediate frequency used in the radio receiver. This may result in interference from this station being present at all dial settings of the radio. To overcome this condition it is only necessary to shift the intermediate frequency up or down about 10 kc. This necessitates readjusting the I.F. units and re-balancing and realigning the R.F. circuits.

**ALL-WAVE ANTENNA SYSTEMS**

There are available, on the market, many so called all-wave antenna systems. These are particularly helpful in locations where there is a great deal of "man made" interference in that the lead-in of such a "balanced" system picks up neither signal nor interference, all pick-up being from the top portion of the antenna. This then, can be placed far enough from the sources of interference to greatly improve results. (International Kadette General Service Manual)

**THE HISTORY OF RADIO**

Considerable effort and research have been applied toward the compilation of a chronological history of radio dating from 600 B.C. to the present day. The history, which is authentic and highly instructive, has been written especially for the March issue of Radio-Craft which is the special JUBILEE SOUVENIR NUMBER. Other features in this issue will be Reminiscences of Old-Timers, Progress of Radio Receivers, Growth of Broadcasting, the Development of Radio Circuits, etc., etc.—all in addition to the regular monthly departments. Reserve your copy of the March issue now; otherwise they may be sold out.







## ADVERTISERS' INDEX

<b>A</b>	
Aerovox Corporation.....	504
Allied Radio Corporation.....	487
American Television Institute, Inc.....	507
Amplifier Company of America.....	506
<b>B</b>	
The Brush Development Company.....	495
Burstein-Applebee Company.....	504
<b>C</b>	
Capitol Radio Engineering Institute.....	504
Central Radio Laboratories.....	509
Cornell-Dubilier Corporation.....	506
Coyne Electrical School.....	490, 451
<b>D</b>	
Dale Radio Co., Inc.....	496
Dodges' Institute.....	492
<b>G</b>	
G&G Genuine Majestic Refrigerator and Radio Parts Service.....	501
Goldentone Radio Company.....	492
Grenpark Company.....	502
<b>H</b>	
Hammarlund Manufacturing Co.....	494
Hudson Specialty Company.....	508
Hygrade Sylvania Corporation.....	503
<b>I</b>	
Imperial Model Aero Supply.....	495
International Resistance Co.....	511
<b>K</b>	
Kenyon Transformer Co., Inc.....	498
<b>L</b>	
Lancaster, Allwine & Rommel.....	511
Lincoln Engineering School.....	506
<b>M</b>	
Million Radio & Television Labs.....	496
Modell.....	500
<b>N</b>	
National Radio Institute.....	440
National Schools.....	500
National Union Radio Corp.....	495
New Ideas Magazine.....	511
New York YMCA Schools.....	494
<b>P</b>	
Precision Apparatus Corporation.....	506
Private Stationery Company.....	505
<b>R</b>	
RCA Institutes, Inc.....	498
Radio Circular Company.....	494
Radio City Products Company.....	500
Radio Constructors Labs.....	501
Radio Publications.....	508
Radio & Technical Publ. Co. (Back Cover)	
Radio Training Assoc. of America.....	490
Radolek Company.....	511
Raytheon Production Corp.....	489
Readrite Meter Works.....	507
Hemington Rand, Inc.....	511
John F. Rider.....	488
The Rosieruelan Order.....	506
<b>S</b>	
Solar Manufacturing Co.....	498
Sprayberry Academy of Radio.....	493
Standard Transformer Corp.....	491
Superior Instrument Company.....	Inside Back Cover
Supreme Instruments Corp.....	491
<b>T</b>	
Tavella Sales Company.....	506
Technifax.....	506
Teleplex Company.....	504
William A. Thomas Co.....	500
Tribbett Elect. Instrument Co.....	505
<b>U</b>	
Utah Radio Products Company.....	492
<b>W</b>	
Montgomery Ward & Company.....	509
Wellworth Trading Company.....	512, 505
Weston Elect. Instrument Corp.....	489
Wholesale Radio Service Co., Inc.....	497
Wright-DeCoster, Inc.....	500
<b>Z</b>	
Zephyr Radio Company.....	498

(While every precaution is taken to insure accuracy, we cannot guarantee against the possibility of an occasional change or omission in the preparation of this index.)

**POISONS, POTIONS, AND PROFITS—The Antidote to Radio Advertising.** by Peter Morell. Published by Knight Publishers, Inc. Size, 6 x 9 ins.; 327 pages. Price \$2.

"Poisons, Potions, and Profits," like its predecessor, "100,000,000 Guinea Pigs," takes advertisers to task for fraudulent claims made in their advertising. It differs from "100,000,000 Guinea Pigs," however, in that it limits its attack to radio advertisers only.

The author states that due to the laxity of the radio censorship laws manufacturers are permitted to make misleading and totally false claims concerning their products—claims which would not be permitted in print. Actual sales talks as obtained by dictaphone, as well as laboratory analyses are given to prove his point.

The effect upon the reader is that he feels that by merely turning the dial of his radio set he is risking his life and health.

(L.F.)

**HANDBOOK OF BROADCASTING.** by Waldo Abbot. Published by McGraw-Hill Book Company, Inc. Size, 6 x 9 ins., cloth covers. 424 pages. Price, \$3.50.

The Assistant Professor of Speech at the University of Michigan, and director of a broadcasting service, as well as the holder of several other important technical positions, author Abbot brings to his subject valuable, practical experience. His book on "How to Broadcast Effectively" is extensive and apparently complete. The few random chapter headings selected from its large contents listing are partially representative of the unusual scope of this well-written, semi-technical volume for the serious radio entertainer.

Chapter I—The Networks (Definition, Advantages and Disadvantages, Relations with Outlets, Studios, Microphones, Control Room, Telephone Transmission); Chapter II—The Broadcasting Station (Local or Outlet Station, License, Radio Waves, Transmitter, Antenna, Directional Antenna, Station Staff); Chapter III—Electrical Transcriptions (Pickups and Turntables, Transcriptions, Service, Libraries).

The following additional chapters are treated in equivalent detail: Chapter V—Radio Speaking; Chapter VIII—Radio Pronunciation, Articulation, Dialects; Chapter IX—Writing Commercial Continuity; Chapter XII—Development of a Plot into a Radio Play; Chapter XVII—Broadcasts to Schools; Chapter XXII—The Law as It Affects Broadcasting; Assignments (Suggested class assignments; bibliography of periodical articles).

**NOT TO BE BROADCAST,** by Ruth Brindze. Published by The Vanguard Press. Size, 5½ x 8½ ins., cloth covers, 310 pages. Price, \$2.50.

Everyone who listens to a radio program should read Ruth Brindze's book. It not only takes you in back of the microphone—but it transports you right into the conference room and shows you exactly what the sponsors, the broadcast systems and the government actually thought and did about past radio programs. The precedences which have been set by 17 years of broadcast operation are analyzed and much of the hokum we feel sure exists, from time to time, in a program is analyzed. We repeat, every intelligent radio listener-in should read this book if only in the interest of wishing to honestly appreciate the best efforts being put forth throughout our system of American radio broadcasting.

**SERVICING SUPERHETERODYNES.** by John F. Rider. Published by John F. Rider. Size, 5 x 7½ ins.; 308 pages. Price, \$1.00.

Any radio library—and we mean *any*—that does not include "Servicing Superheterodynes" must be considered incomplete. This new, revised edition contains an entirely new Intermediate Frequency list; an appendix has been added to the book.

This volume is the most complete, practical book on superheterodyne receivers that insofar as this reviewer is aware has so far been published. When it is realized that about 95% of all radio sets utilize superheterodyne circuits the importance of such a book becomes evident.

Chapter headings follow: Introduction; The Principles Underlying the Operation of the

## BOOK REVIEW

Superheterodyne Receiver; The Generation of and the Relation Between Harmonics; Explanation of the Different Types of Circuits; Function and Characteristics of Components; Special Circuits and Tube Applications; Troubles and Symptoms; Application of Test Oscillators; Recent Advances in the Superhet.; I.F. Peaks of Commercial Receivers.

**MARINE ELECTRIC POWER.** by Captain Q. B. Newman. Published by Simmons-Boardman Publishing Corp. Size 5 x 8¾ ins.; 156 pages. Price, \$2.00.

This book presents fundamental electrical and radio theory in a style that is refreshingly simple. Captain Newman hardly seems to leave even the "A" of the motor theory alphabet; yet, the reader of this interesting volume will find that he has assimilated an amazing amount of basic and essential information on the subject's topic.

Chapter titles selected at random convey a general idea of the contents: Chapter I—The Common Sense View; Different Ways to Rotate a Shaft; Electro-Magnets. Polarity; Electro-Magnets; Strength of Field. Chapter II—The Cycle; Rotating Magnetic Field. Chapter IV—The Generator; The Voltage Cycle. Chapter VIII—Power With Lagging Current; Leading Current. Chapter XI—Propelling Motor; Reversing. Chapter XX—Resistance and Inductance; Capacitance.

This book is essentially non-mathematical in treatment but nevertheless algebraic formulas are quite freely used. States the author, "The justification for this is simply that in no other way can information be recorded quite so briefly, clearly, and simply."

**EVERYDAY SCIENCE,** by A. W. Haslett. Published by Alfred A. Knopf. Size, 5½ x 8½ ins., cloth covers, 317 pages. Price, \$2.75.

Here is a book that sugar-coats the scientific bases of modern life. Books of this sort ordinarily present their story in chronological order from earliest times forward; the author of "Everyday Science," instead, correlates his data under such chapter headings as "King Coal," "Science and Crime," "The Problems of Waste," etc.

The book is published in New York, but the English author has indexed it "Radio, see Wireless." Under this out-of-date designation (obsolesced by international agreement many years ago) our "Foundation Scholar of King's College, Cambridge (England)," has compiled, in the chapter on the problems of waste, some unusually interesting figures. For example, he estimates the overall efficiency of radio reception to be less than 1/10,000th of 1 per cent! All in all, an interesting semi-technical science presentation.

## PYRO PANTAGRAPH



THIS electrical outfit is especially designed for burning designs permanently on materials such as Leather, Wood, Cork, Bakelite, etc.

VOGUE Shipping Wt. 3 lbs

Plug the Pyro-electric pencil in any 110 volt AC or DC outlet and it is ready to be used. Plug and cord furnished.

By the use of the Pantagraph included in the outfit, any design may be reproduced either in original, reduced or enlarged form.

Outfit consists of: one Pyro-electric Pencil; one Pantagraph; three hardwood plaques; one bottle of Varnish; one Brush; one tracing tip and four-page instruction sheet.

Size of box: 12½ x 8½ inches.

Outfit will be forwarded by Express Collect if not sufficient postage included with your order.

**WELLWORTH TRADING CO.**

558 W. Washington Blvd., Dept. RC-238, Chicago, Ill.

Please Say That You Saw It in RADIO-CRAFT



# NEW INSTRUMENTS BY SUPERIOR . . .

**COMBINATION ALL-WAVE  
SIGNAL GENERATOR**  
Plus  
**A COMPLETE TUBE TESTER**  
Only \$19.90



Truly the greatest value ever offered by any instrument manufacturer! There is no comparison to this COMBINATION INSTRUMENT, made by Superior, at the price of \$19.90. Consists of two fully complete units housed in a single metal cabinet of attractive design: (1) an ALL-WAVE SIGNAL GENERATOR and (2) COMPLETE TUBE TESTER. The Signal Generator has a range of from 110 Kc. to 22 mc., all fundamental frequencies, in five bands—with front panel band-switching control. All frequencies are directly calibrated on the dial and a 4 to 1 planetary drive is incorporated to allow for slow precise tuning adjustment. R.F. signal with or without audio modulation, at the control of the operator. Separate R.F. and A.F. outputs, with two A.F. amplitude levels. Accuracy 1 per cent on I.F. bands, 2 per cent on short-waves. Separate Neon leakage test circuit, for testing condensers, etc. Employs two tubes, 2-4A7's and one special neon modulator tube. The TUBE TESTER tests all 4, 5, 6, 7 and octal base tubes, including diode tubes. Incorporates separate neon short or leakage test, to determine whether tubes are bad, noisy or leaky. English reading meter, with "BAD-7-GOOD" scale. Uses minimum number of operating controls. Allowing tube tests to be made quickly and accurately. Sturdy, reliable and foolproof emission type circuit.

Shipping weight 15 lbs.

## THE RC BOX SOLVES PUZZLING PROBLEMS IN CAPACITY AND RESISTANCE REPLACEMENTS; ALSO USE- FUL AS STANDARDS OF CAPACITY AND RESISTANCE.



### SPECIFICATIONS

Direct-reading, 0-40 ohms, at 10 watts maximum allowable power dissipation. Direct-reading, 0-20,000 ohms, at 3 watts maximum allowable power dissipation. Direct-reading, 0-1,000,000 ohms (1 meg.) at 1 watt maximum allowable power dissipation. Direct-reading, 10-100 mfd. (1000-10000 mfd.), at 200 peak volts allowable maximum. Direct-reading, 100-150 mfd. (1,000-1,000,000 mfd.), at 200 peak volts allowable maximum. Rheostats of specially selected material for retention of calibrated values, including wire-winding of the 40 and 20,000-ohm units. Tuning condensers of exceptional quality (excellent power factor). Two separate binding posts for each of the six different services, all clearly designated. (Rotor of two-range condenser is common to two posts, upper left and upper right). Accuracy is 2 per cent for all capacity settings, also for all settings of the 40 and 20,000-ohm resistors; 5 per cent for the 1,000,000-ohm unit. Instrument is totally shielded, so that spurious effects due to stray pictures, affecting exactly measurements particularly, are avoided. One of the common rotor posts may be used as ground when the other condenser or any of the two-range condenser is being used. Overall size of instrument is 10x6 1/2x4 inches. Black wrinkle finish cabinet has carrying handle. Net price \$6-10

Shipping weight 4 lbs.

**ORDER DIRECT FROM** →

# SUPERIOR VALUE IN SUPERIOR INSTRUMENTS MAKES YOU WANT SUPERIOR'S TEST EQUIPMENT!

MR. SERVICEMAN—You can't afford to overlook the values in SUPERIOR'S instrument line. Such outstandingly low prices for equipment that has gained rapid popularity proves that service shops are being equipped with SUPERIOR'S stationary and portable servicing instruments. This advertisement is your buying guide . . . use it to your advantage!

## 27 Instruments in 1 THE ALLMETER 1,000 OHMS PER VOLT



The ALLMETER permits both A.C. and D.C. measurements for volts and currents, also low resistances from below one ohm, also high resistance capacities, one ohm, also high resistance capacities, instruments, in one.  
1—A.C. Currents, 15-150-750 ma. This never afforded by multimeter instruments.  
Instruments, 3.  
2—A.C. Volts, 15-150-750 volts. Affords also output meter service, instruments, 3.  
3—CAPACITY, 0.1-50 mfd., all condensers, including electrolytics; Instruments, 4.  
4—5-1,000 Henries, coil loaded or not.  
5—LOW ohms, 1-03-500 ohms. Extremely valuable, instruments, 1.  
6—HIGH ohms, to 0.5 meg., covering all practical values, instruments, 1.  
7—D.C. Volts, 15-150-750 volts. Simplified scale uses same calibration as for a.c. instruments, 3.  
8—D.C. Currents, 15-150-750 ma. The same scale simplification, also 0-1 milliamperes, instruments, 4.  
9—Decibels, -12 to +10. Instruments, 3 + 8 - + 30 (by interpolation) + 8 - + 50 by interpolation.  
10—Vacuum-tube voltmeter, 0.15-150; 750 volts A.C. D.C. Instruments, 6.  
11—Continuity tester. In instruments, 1. Shipping wt. 8 lbs. Net price \$10.40

## THE INFINOMETER AN ACCURATE V. T. VOLTMETER \$14.40 Complete



Measures Critical Voltages in Low-Current Circuits, Such as in Volume Expanders, A.V.C., A.F.C., DC Amplifiers, Photocell Circuits, Etc.  
Operates from 110 Volts DC or AC (any frequency). With Less Than 5% Error on High Voltage Ranges Due to Line-Voltage Fluctuations.  
Three DC Ranges: 0-6, 20 and 60 Volts; Four A.C. Ranges: 0-3, 15-50 and 150 Volts. Sensitivity approximately 700,000 Ohms per Volt on DC Ranges; Approximately 300,000 Ohms per Volt on AC Ranges.

Shipping weight 5 lbs.

## VOLT-OHM-MILLIAMMETER



The HAND-METER, a new volt-ohm-milliammeter, gives direct reading of d.c. volts 0.5/5/50/500, also ohms, and 20,000, likewise direct-reading, and d.c. current determination to 20 milliamperes. Low ohms scale as a 4-c. coil, ing r.f. and i.f. opens. Low-priced instrument never before included low-ohms range, reading to one ohm, nor did they have an adjustable range of ohms readings. Complete with test leads and self-contained batteries. Shipping weight 5 lbs. Net price \$4-10

## GENEMETER



WITH VARIABLE AUDIO FREQUENCIES  
\$14.40  
Complete with Four Tubes

Combination R.F. and Audio Signal Generator, R.F. direct reading, all by front panel switching, 25-10,000 cycles, all R.F. and A.F. outputs independently obtainable, or with A.F. (any frequency) modulating R.F.  
Output meter for connection across primary modulation transformer for peaking with R.F. is subject to attenuation, and oscillation leakage is minimum.  
Condenser and other leakages tested to 100 to-1 vernier planetary drive.  
Main dial protected on 7 1/2" diameter, and 4-100 ft. to 105 A.C. A.F. 25-10,000 cycles, all R.F. and A.F. outputs independently obtainable, or with A.F. (any frequency) modulating R.F.  
Output meter for connection across primary modulation transformer for peaking with R.F. is subject to attenuation, and oscillation leakage is minimum.  
Condenser and other leakages tested to 100 to-1 vernier planetary drive.  
All services on 9-150 volts a.c. or d.c.  
Shipping weight 10 lbs.

## MODEL V-45 TUBE TESTER Emission type perfected tube tester for any and all type receiver tubes, including metal and metal-glass. Tests shorts and leakage. Accurate, simple, sturdy, direct — English — reading (Bad-Good). . . . .



Shipping weight 9 lbs.

**FREE Catalog!**



**SUPERIOR INSTRUMENT COMPANY**  
136 LIBERTY STREET DEPT. P NEW YORK, N. Y.



# 41 THINGS EVERY RADIO SERVICE MAN *Must Know!*



## Ghirardi gives you instant command of servicing essentials in 2 HANDY BOOKS

You've got to know a lot to even just "hold-your-own" in the radio servicing game today. But you won't need to worry if you have MODERN RADIO SERVICING & RADIO FIELD SERVICE DATA at your elbow. These two great Ghirardi servicing books explain every phase of radio service work and will tell you exactly how to handle every servicing problem you'll ever run up against. The first book tells you HOW and WHAT—the other supplies instantly all the necessary receiver and servicing reference data right WHEN and WHERE you need it on a servicing job—with a regular Supplement Sheet Service to keep it up to date at all times.

### A HARD-HITTING COMBINATION!

This "double-barrelled combination" will give you both servicing "background" and "theory"—the "41 Essentials" of successful servicing—all clearly explained in easy-to-understand language. You need both of these books on your service bench right away. Together, they give you a total of 1800 pages of priceless servicing dope with 813 diagrams and illustrations to make everything perfectly clear—all for only \$6. You can't pass up this big Combination Offer. Grab it Now! Fill out the coupon below, and Mail it Today! Your Money Back if not completely satisfied. Both books sent Postpaid Anywhere!

### These Men Were Smart!

They bought these two Ghirardi servicing books. Read what they say about them now:

- "More data and information in these 2 volumes than a 4-year engineering course and always at your finger tips."—E. B. Marcellus, Mich.
- "The tops in radio service information."—F. M. S. Crawfordville, Ind.
- "Like 1,000 hours additional experience."—J. M. H. Bad Ace, Mich.
- "The best books in my collection. None better."—J. H. M., Lancaster, Pa.
- "Had I purchased MODERN RADIO SERVICING before this time, I would not have had to invest all the money I did in other radio books with just half the information this 1 volume has."—R. C. P., Minneapolis, Minn.
- "These two books are the best investment I ever made in radio publications, and I have quite a Radio Library. They can't be beat!"—R. S. B., Broadalbin, N. Y.
- "One big volume comprising the very best instruction course in modern radio service work plus a loose-leaf 'Case History' and servicing reference data book for use on the job. Smart radio servicemen will jump for both of them!"—AEROVOX RESEARCH WORKER.

Don't Risk A Penny Money-Back Guarantee Protects You! MAIL COUPON NOW!



- 1 TEST INSTRUMENTS**  
A 420-page section which gives you the whole theory and construction of every type of test and servicing equipment, with diagrams, construction data, "How-They-Work" descriptions of commercial models, etc., etc. Here's basic test-instrument knowledge for every service man.
- 2 TROUBLE-SHOOTING**  
284 pages of latest short-cut methods to use in analyzing all kinds of receiver troubles, AVC and QAVC circuits, tuning indicators, how to service circuits.
- 3 REPAIR METHODS**  
184 pages of time-saving instructions for making the actual repairs in all types of receivers and individual components. How to align superheterodyne method. How to get rid of noise, electrical interference, intermittent reception, hum, distortion, etc.
- 4 SPECIALIZED SERVICING**  
442 pages of specialized servicing information covering Auto-Radio installation and servicing, All-Wave, High Fidelity, and Marine set servicing, Selling Service, etc.
- 5 CASE HISTORIES, etc.**  
The world's greatest collection of "Case Histories"—for over 1500 different receivers—in the Data Book. Also—the 1, F's for over 6,000 superhets, Auto-Radio installation instructions for all cars, tube data, and 25 other invaluable charts and tables for instant reference in the shop or out on the job.

**MODERN RADIO Servicing and RADIO FIELD SERVICE DATA BOOK BOTH BOOKS—Only \$6**

To: Radio & Technical Publ. Co.  
Dept. RC-28, 45 Astor Place, New York

Here's \$6 for my copies of MODERN RADIO SERVICING and RADIO FIELD SERVICE DATA (write the Jan. and June '37 Supplements to Data Book) Postpaid. (\$8.50 foreign)

Please send me free descriptive literature about these 2 servicing books.

NAME .....

STREET .....

CITY .....



*Got down your Order on a piece of Paper—*

If you don't want to tear out the coupons, just take a piece of paper or your business card—jot down the titles of the books and Pocket Trouble Shooters you want, together with your name and address—enclose the amount stated in these ads—and mail to:

**RADIO & TECHNICAL PUBLISHING CO.**  
Dept. RC-28, 45 Astor Place, New York, N. Y.

**Get a whole shelf-full of RADIO BOOKS**

**IN ONE BIG VOLUME \$4-**

**THE COMPLETE Ghirardi RADIO PHYSICS COURSE**

- CLEAR
- COMPLETE
- UP-TO-DATE
- ECONOMICAL

One big book now takes the place of 36! Ghirardi's best-selling RADIO PHYSICS COURSE compresses the world's knowledge of radio, electricity and sound between the covers of this great 972-page volume. Don't be satisfied with the drab old books you get when you buy a lot of "little" books. Ever figured up how much they cost you all together? Get "Ghirardi" and get it all—a whole library in 1 big book—for only \$4! The ideal way to learn radio and fill yourself for a better job. You don't have to "study"—just read, and the whole subject is made so plain and easy you can't ever forget it. Hundreds of illustrations make it quick to grasp. Serious students all over the world use it more than any other radio text. You, too, can learn radio from Ghirardi's RADIO PHYSICS COURSE. Clip the coupon and get it now! It's guaranteed!

**What You Will Learn From This Book**

Sound, Speech and Music . . . Electrons . . . Electric Current Units and Circuits . . . Resistance . . . Ohm's Law . . . Batteries . . . Magnetism . . . Electromagnetism . . . Transformers . . . Inductance . . . Condensers . . . Alternating Current Circuits . . . Filters . . . Electrical Measuring Instruments . . . Radio Waves and Radiations . . . Broadcast Stations . . . Receiving Equipment . . . Vacuum Tubes . . . Radio and Audio Frequency Amplification . . . Superheterodynes . . . Loud Speakers . . . Battery Operated Receivers . . . Power Supply Units . . . Electric Receivers . . . Automobile and Aircraft Receivers . . . Phonograph Pickups . . . P.A. Systems . . . Short-Wave Receivers . . . Photoelectric Cells . . . Television . . . Antennas and Grounds . . . Testing and Servicing Receivers . . . Sound Motion Pictures . . . Appendices . . . 856 Review Questions for Self-Study . . . AND LOTS MORE!

**Snip this Coupon out! -MAIL IT NOW!**

To: RADIO & TECHNICAL PUBL. CO.  
Dept. RC-28, 45 Astor Place, New York, N. Y.

Send me \$4. Send my RADIO PHYSICS COURSE at once, postage paid (Foreign \$4.50) book.

Name .....

Street .....

City .....

**MONEY-BACK GUARANTEE!**

**For HOME Radios For AUTO Radios**

**HOME-RADIO POCKET TROUBLE SHOOTER** **AUTO RADIO POCKET TROUBLE SHOOTER**

**Servicing!**

**IS 10 TIMES FASTER - WHEN YOU USE THE "Twin-Gadgets"**

**SPEED UP YOUR SERVICE WORK** with these new fast-working Gadgets. How do they work? Easy as pie—you take up your Gadget. Pick out the card marked for the Trouble Symptom you find in the sick receiver; flip the card around—there have all the tests to make and all the remedies, set down next to all the possible trouble sources. It works quicker than it can be described. A half second's time and you have all the data you want right before your eyes. The most ingenious servicing aid ever invented. OVER 400 DIFFERENT SET "TROUBLES" are spotted on each of the Gadgets. You need both of them to cover all jobs—use for HOME RADIO sets and one for AUTO RADIO sets. And all they cost is \$1 A PAIR (\$1.25 foreign)—only \$1 to save you hours and hours of headaches, worry and wasted time. Don't delay—get your Gadgets today and let them earn money for you. Write your name and address on the card and send it in with a dollar today! Sent postpaid anywhere on 5-day trial!

**GHIRARDI'S POCKET TROUBLE SHOOTERS**  
Radio & Technical Publ. Co., Dept. RC-28, 45 Astor Place, New York, N. Y.

**MAIL \$1 NOW! MONEY-BACK GUARANTEE!**